

HI99163

Portable Waterproof Meat pH Meter



INSTRUCTION MANUAL

**Dear
Customer,**

Thank you for choosing a Hanna Instruments product. Please read this instruction manual carefully before using this meter.

This manual will provide you with the necessary information for correct use of this meter, as well as a precise idea of its versatility.

If you need additional technical information, do not hesitate to e-mail us at tech@hannainst.com or view our worldwide contact list at www.hannainst.com.

All rights are reserved. Reproduction in whole or in part is prohibited without the written consent of the copyright owner, Hanna Instruments Inc., Woonsocket, Rhode Island, 02895, USA.

TABLE OF CONTENTS

Table of Contents.....	3
Preliminary Examination	4
General Description and Intended Use.....	5
Main Features	6
Specifications	7
Display Description	8
Operational Guide	9
Meter Setup	14
Battery Replacement.....	15
Accessories.....	16
Electrode Maintenance.....	17
Certification.....	18
Recommendations for Users	19
Warranty	19

Remove the meter from the packing material and examine it carefully to make sure that no damage has occurred during shipment. If noticeable damage is evident, contact your local Hanna Instruments Office.

Each meter is supplied complete with:

- **FC2323** amplified pH/temperature probe with stainless steel blade, DIN connector and 1 m (3.3') cable
- pH 4.01 & 7.01 Buffer sachet
- **HI700630** grease and fats acid cleaning solution (2 sachets)
- 100 mL beaker (1 pc.)
- Alkaline batteries: 1.5V AAA (3 pcs.)
- Rugged carrying case
- Calibration certificate of meter
- Calibration certificate of probe
- Instruction manual

Note: Save all packing material until you are sure that the meter functions correctly. All defective items must be returned in the original packing together with the supplied accessories.

A reliable pH measurement is an important factor in the field of meat science. pH affects many quality factors including color, grading, tenderness, texture and process characteristics. A direct measurement of muscle pH, deep in the muscle is the best way to determine the pH of the muscle.

HI99163 is a portable pH and temperature meter with a special probe, dedicated to the measurement of pH in meat processing. The **HI99163** has a waterproof and compact casing, large dual-line display, and automatic pH calibration at one or two points. The meter works at cold store operating temperatures to 0 °C (32°F).

The **FC2323** probe has been specially designed for meat processing and comes with a removable stainless steel lance for meat/muscle penetration. The **FC2323** is a penetration style pH electrode with a conical sensing tip and features an easy to clean, PVDF body and single junction gel filled reference with a free diffusion sleeve style reference junction. A built-in temperature sensor allows simultaneous temperature compensated pH and temperature readings and an integral pH sensor preamplifier provides measurements impervious to noise and electrical interferences often experienced at cold temperatures with conventional pH equipment.

The **FC2323** electrode with the stainless steel pointed blade attached, together with the **HI99163** pH meter are ready for portable pH measurements in intact muscle in meat processing operations.

MAIN FEATURES

Main features:

- Simultaneous pH and temperature measurements on a large dual-line LCD display
- Automatic pH calibration at one or two points within two memorized buffer sets (standard or NIST)
- Selectable temperature unit ($^{\circ}\text{C}$ or $^{\circ}\text{F}$)
- Electrode condition indicator
- mV of pH measurement for electrode check
- FC2323 dedicated pH with integral temperature sensor
- Probe quick connect system
- Battery life indication and low battery detection
- Keystroke confirmation tone
- Auto-off function
- Waterproof casing IP67

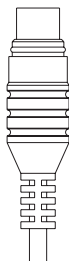
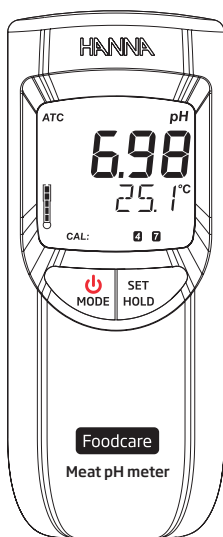

Range*	-2.00 to 16.00 pH / -2.0 to 16.0 pH ±825 mV (pH-mV) -5.0 to 105.0 °C/23.0 to 221.0 °F
Resolution	0.01 pH / 0.1 pH 1 mV 0.1 °C/0.1 °F
Accuracy @ 20 °C / 68 °F	±0.02 pH / ±0.1 pH ±1 mV (pH-mV) ±0.5 °C up to 60 °C; ±1.0 °C outside ±1.0 °F up to 140 °F; ±2.0 °F outside
Temperature compensation	Automatic -5.0 to 105.0 °C/23.0 to 221.0 °F
pH Calibration	Automatic, 1 or 2 point selectable buffer set Standard: 4.01; 7.01; 10.01 or NIST: 4.01; 6.86; 9.18
Probe (included)	FC2323 amplified pH/temperature probe with stainless steel blade, DIN connector and 1 m (3.3') cable
Battery type / life	1.5V AAA (3 pcs.) approx. 1400 hours of continuous use
Auto-Off	user selectable: after 8 min, 60 min or disabled
Environment	0 to 50 °C (32 to 122 °F) RH max. 100%
Meter Dimensions	154 x 63 x 30 mm (6.1 x 2.5 x 1.2")
Meter Mass (with batteries)	196 g (6.91 oz.)
Case Ingress Protection Rating	IP67

* the **FC2323** is limited to be used from 0 to 12 pH and from 0 to 50 °C temperature (32 to 122 °F).

DISPLAY DESCRIPTION

- 1 Automatic Temperature Compensation indicator
- 2 Stability indicator
- 3 Battery percentage
- 4 Electrode condition indicator
- 5 Low battery indicator
- 6 Measurement unit
- 7 Primary LCD
- 8 Temperature unit
- 9 Secondary LCD
- 10 Meter modes indicator
- 11 pH calibration buffer(s) used

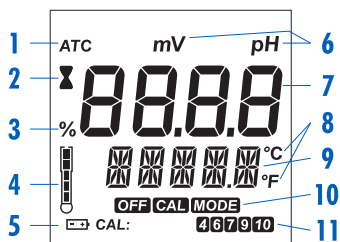

Each meter is supplied with batteries. Before using the meter for the first time, open the battery compartment and insert batteries, observing the polarity (see “Battery Replacement”).

TO CONNECT THE ELECTRODE

With the meter turned off, connect the FC2323 probe to the DIN socket on the bottom of the meter by aligning the pins and pushing in the plug firmly. Remove the protective cap from the probe before taking any measurements.

TO TURN THE METER ON



To turn the meter ON, press the  button on the front of the meter. If it does not turn on, make sure that the batteries are properly installed in their place. The meter is provided with an active acoustic signal when a key is pressed. At start-up the meter displays all LCD segments for a few seconds, followed by the percentage indication of the remaining battery life, displaying “WAIT” until electrode check is in process then the meter enters the normal measurement mode.

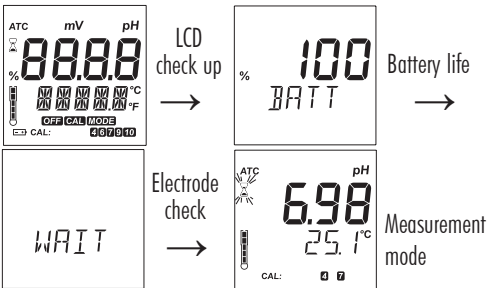

Note: The meter detects the presence and the type of the probe at its input.

- If the probe is not connected the message “NO” “PROBE” appears alternatively on the secondary LCD with “---” blinking on the first LCD line.
- If the probe is not compatible “WRONG” “PROBE” message appears alternatively on the secondary LCD with “---” blinking on the first LCD line.
- If the readings are out of range, the nearest range limits are displayed blinking (E.g. -2.00 pH -5.0 °C).

TO SELECT THE MEASUREMENT RANGE

While in measurement mode, press the **SET** button to select pH or pH-mV measurement on the first LCD line.

TO FREEZE THE MEASUREMENT VALUES

While in measurement mode, press and hold the **SET** button until "HOLD" appears on the secondary LCD. The "HOLD" remains for 1 second and reading of pH, mV and temperature will be frozen on the LCD with "H" blinking.

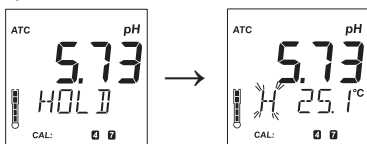

Press any button to resume active measurements.

TO ENTER CALIBRATION MODE

Press and hold the **⏻** button until "POWER" and **OFF** tag is replaced by "STD" and **CAL** tag. Release the button.

TO ENTER SETUP MODE

Press and hold **⏻** button until "STD" and **CAL** tag is replaced by "SETUP" and **MODE** tag. Release the button.

TO TURN THE METER OFF

While in measurement mode, press the **⏻** button. "POWER" and **OFF** tag will appear. Release the button.

pH MEASUREMENT & CALIBRATION

Make sure the meter has been calibrated before use.

If the probe is dry, soak it in **HI70300** storage solution for 30 minutes to reactivate it. If fouled, clean the electrode by soaking in cleaning solution for 20 minutes, then rinse the tip and soak in storage solution at least 30 minutes before use.

Rinse the electrode off well and shake off excess droplets. Recalibrate before using.

Submerge the probe in the sample to be tested while stirring it gently. Wait until the **⌚** tag on the LCD disappears.

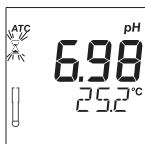

The LCD displays the pH value (automatically compensated for temperature) on the primary LCD, while the secondary LCD displays the sample temperature. If measurements are taken in different samples successively, rinse the probe tip thoroughly† to eliminate cross-contamination.

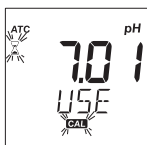

For better accuracy, frequent calibration of the pH sensor with the meter is recommended. In addition, the meter must be recalibrated whenever:

- a) The pH electrode is replaced.
- b) After testing aggressive chemicals.
- c) Where high accuracy is required.
- d) At least once a month.
- e) After cleaning the sensor.

† *The probe tip should be rinsed with purified water (reverse osmosis, distilled, or deionized) before and after placing in any solution (buffer, storage or sample).*

pH calibration

Enter calibration mode while in pH measurement mode. Place the sensor into the first calibration buffer. If performing a two-point calibration, use pH 7.01 (pH 6.86 for NIST) buffer first. The meter will enter the calibration mode, displaying "pH 7.01 USE" **CAL** and ⌚ tag blinking (or "pH 6.86 USE" for NIST).

Follow directions for single and two-point calibration below:

Single-point calibration

1. Place the probe in any buffer from the selected buffer set.
The meter will automatically recognize the buffer value.
2. If the buffer is not recognized or the calibration offset is out of the accepted range "---- **WRONG**" is displayed.
3. If the buffer is recognized "REC" is displayed then "WAIT" until the calibration is accepted.

If using pH 7.01 (or pH 6.86 for NIST), after acceptance of the buffer press any key to exit. The "SAVE" message is displayed and the meter returns to pH measurement mode. If using pH 4.01 or 10.01 (or pH 9.18 for NIST) buffer the "SAVE" message is displayed and meter returns to pH measurement mode.

Two-point calibration

Proceed with steps 1 through 3 under single point calibration using 7.01 (pH 6.86 for NIST) pH buffer first. Then follow steps below:

The "pH 4.01 USE" message is then displayed.

Place the probe in the second calibration buffer (pH 4.01 or 10.01, or, if using NIST, pH 4.01 or 9.18). When the second buffer is accepted, the LCD will display "SAVE" for 1 second and the meter will return to the normal measurement mode.

If the buffer is not recognized or the slope is out of accepted range "--- WRONG" is displayed. Change the buffer, clean the electrode or press any key to exit calibration.

It is always recommended to carry out a two-point calibration for better accuracy.

When the calibration procedure is completed, the **CAL** tag is turned on together with the calibrated points.

To exit calibration and reset default values

After entering the calibration mode and before the first point is accepted, it is possible to quit the procedure and return to the last calibration data by pressing the  button. The LCD displays "ESC" for 1 second and the meter returns to normal mode.

To reset the default values and clear a previous calibration, press the **SET** button after entering the calibration mode and before the first point is accepted.

The LCD displays "CLEAR" for 1 second, the meter resets to the default calibration and the **CAL** tag with the calibrated points on the LCD disappears.

ELECTRODE CONDITION

The display is provided with a probe icon (unless the feature is disabled from setup) which indicates the electrode status after calibration. The “condition” remains active for 12 hours (unless the batteries are removed).

The electrode condition is evaluated only if the current calibration has two points.





With 1 bar it is recommended to clean the electrode and recalibrate. If there is still only 1 bar or 1 bar blinking replace the probe.

Sensor Check

Setting the meter to pH-mV range the user can check the sensor status at any time. The offset value is the reading in pH 7.01 buffer (@ 25 °C/77 °F). If this reading is outside the range ± 30 mV, the electrode is considered “very poor”. The slope value of the sensor is the difference between readings in pH 7.01 and in pH 4.01 buffers. When the slope reaches the value of about 150 mV, the electrode is considered “very poor”. When “poor” or “very poor”, it is recommended to replace it with a new one.

Note: To ensure reliable readings, the electrode must be cleaned with cleaning solution and then hydrated in storage solution for a minimum of 30 minutes before calibrating the probe.

Setup mode allows the selection of the Temperature unit, Auto-off, Beep, the type of pH buffer set, the Resolution and Information. To enter Setup mode press and hold  button until "STD" and **CAL** tag is replaced by "SETUP" and **MODE** tag. Release the button.

- "TEMP" is displayed on the secondary LCD with the current temperature unit (E.g. "TEMP °C"), for °C/°F selection, use the **SET** button. After the temperature unit has been selected, press  to confirm and to enter the "A-OFF" selection.

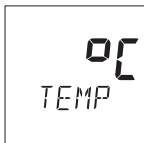

- Use the **SET** button, to cycle through the auto-off choices: 8 minutes ("8", default value), 60 minutes ("60") or disabled ("---"). Press  to confirm and to enter the "BEEP" selection.



- To switch ON or OFF the beep tone, press the **SET** button; press  to confirm and to enter the calibration buffer selection "pH 7.01 BUFF".



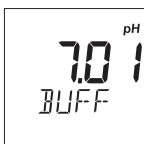

- To change the type of calibration buffer set, the meter will show the current buffer set: "pH 7.01 BUFF" (for standard buffer set: 4.01/7.01/ 10.01) or "pH 6.86 BUFF" (for NIST buffer set: 4.01/6.86/ 9.18). Change the set with the **SET** button. Press  to confirm and to enter pH resolution selection "RESOL".

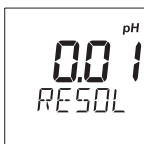

- To change the pH measurement resolution between "0.1" and "0.01" use the **SET** button; then press  to confirm and to enter electrode calibration information "INFO" selection.



- To switch ON or OFF the electrode condition indicator on the LCD, press the **SET** button; press  to exit setup options; Change the set with the **SET** button, then press  to confirm and to return to normal mode.



BATTERY REPLACEMENT

When the remaining battery life is less than 10% the battery tag blinks on the display to warn the user.

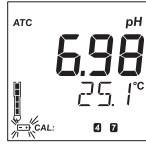

Battery Error Prevention System (BEPS)

If the battery is too weak (“0%”) the display shows “bAtt”, “DEAD” for few seconds then the meter power off. Immediately replace the batteries with new ones.

The batteries are accessed by opening the battery cover on the back of the instrument. Remove protective boot if present.

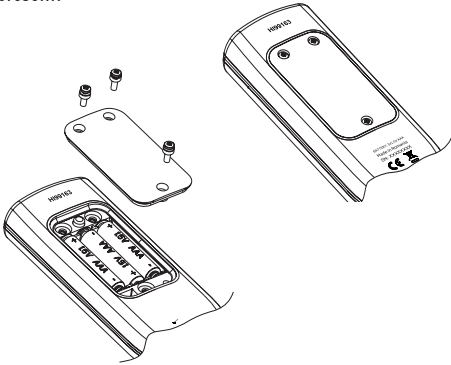

Replace the three 1.5V AAA alkaline batteries located in the battery compartment, observing the indicated polarity.

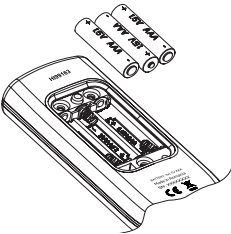

Replace the battery cover making sure that the gasket is in place.

ACCESSORIES

FC2323	Preamplified pH/temperature probe with stainless steel blade, DIN connector and 1 m (3.3') cable
HI7004L	pH 4.01 buffer solution, 500 mL
HI7006L	pH 6.86 buffer solution, 500 mL
HI7007L	pH 7.01 buffer solution, 500 mL
HI7009L	pH 9.18 buffer solution, 500 mL
HI7010L	pH 10.01 buffer solution, 500 mL
HI70300L	pH electrode storage solution, 500 mL
HI7061L	pH electrode cleaning solution, 500 mL
HI70630L	Grease and fats acid cleaning solution, 500 mL
HI710029	Silicon rubber boot blue color
HI76405	Electrode holder
HI77400P	Calibration kit (pH 4 & 7, 20 mL, 5 pcs. each)

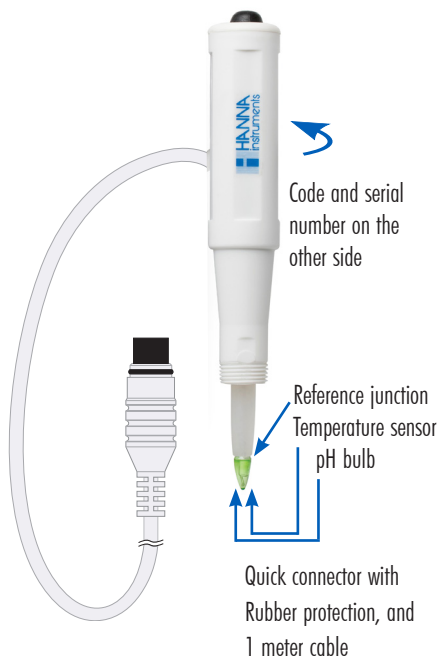

PREPARATION

- Remove the protective cap. DO NOT BE ALARMED IF ANY SALT DEPOSITS ARE PRESENT. Rinse with water.
- Shake the electrode down as you would do with a clinical thermometer to eliminate any air bubbles inside the glass bulb.
- If the bulb and/or junction are dry, soak the electrode in [HI70300](#) Storage Solution for a minimum of 30 minutes.
- Rinse with water.
- Calibrate before using.

STORAGE

- To ensure a quick response, the glass bulb and the junction should be kept moist and not allowed to dry.
- Replace protective cap with a few drops of [HI70300](#) Storage Solution. Follow PREPARATION above before taking measurements.

Note: NEVER STORE THE ELECTRODE IN DISTILLED WATER.

PERIODIC MAINTENANCE

- Inspect the electrode for any scratches or cracks. If any present, replace the electrode.
- Rinse off any salt deposits with water.
- Follow the STORAGE procedure above.

CLEANING PROCEDURE

- Remove the stainless steel blade.
- Soak in Hanna [HI7061](#) General Cleaning Solution or [HI700630](#) grease and fats acid cleaning solution for 20 minutes. Rinse well and calibrate before using.

IMPORTANT: After performing any of the cleaning procedures rinse the electrode thoroughly with distilled water. Soak the electrode in [HI70300](#) Storage Solution for a minimum of 30 minutes. Rinse with water. Calibrate before using.

TROUBLESHOOTING

- pH Meter: Follow the meter's operating and calibration procedures.
- Electrode: Evaluate your electrode performance based on the SENSOR CHECK procedure on page 13.

All Hanna Instruments conform to the **CE European Directives**.



RoHS
compliant

Disposal of Electrical & Electronic Equipment. The product should not be treated as household waste. Instead hand it over to the appropriate collection point for the recycling of electrical and electronic equipment which will conserve natural resources.

Disposal of waste batteries. This product contains batteries, do not dispose of them with other household waste. Hand them over to the appropriate collection point for recycling.

Ensuring proper product and battery disposal prevents potential negative consequences for the environment and human health. For more information, contact your city, your local household waste disposal service, the place of purchase or go to www.hannainst.com.



Recommendations for Users

Before using this product, make sure it is entirely suitable for your specific application and for the environment in which it is used. Any variation introduced by the user to the supplied equipment may degrade the meters' performance. For yours and the meter's safety do not use or store the meter in hazardous environments.

Warranty HI99163 is warranted for two years against defects in workmanship and materials when used for its intended purpose and maintained according to instructions. This warranty is limited to repair or replacement free of charge. Damage due to accidents, misuse, tampering or lack of prescribed maintenance is not covered.

If service is required, contact your local Hanna Instruments Office. If under warranty, report the model number, date of purchase, serial number (see engraved in the back of the meter) and the nature of the problem. If the repair is not covered by the warranty, you will be notified of the charges incurred. If the meter is to be returned to Hanna Instruments, first obtain a Returned Goods Authorization number from the Technical Service department and then send it with shipping costs prepaid. When shipping any meter, make sure it is properly packed for complete protection.

Hanna Instruments reserves the right to modify the design, construction or appearance of its products without advance notice.

World Headquarters

Hanna Instruments Inc.
Highland Industrial Park
584 Park East Drive
Woonsocket, RI 02895 USA
www.hannainst.com

Local Office

Hanna Instruments Inc.
270 George Washington Highway
Smithfield, RI 02917
Phone: 800.426.6287
Fax: 401.765.7575
e-mail: tech@hannainst.com