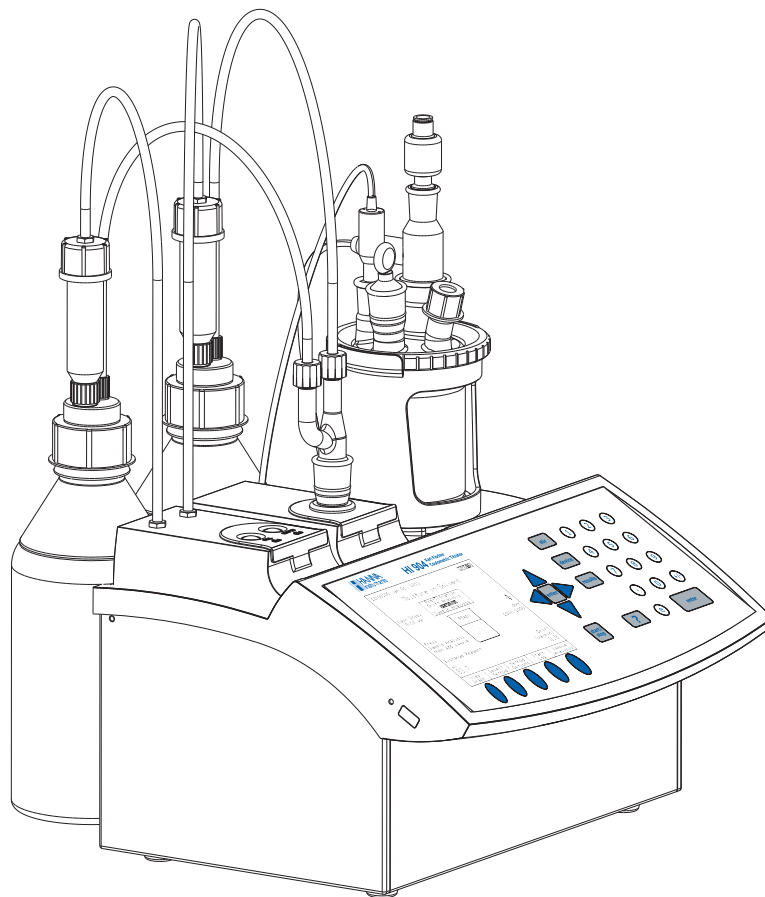

QUICK START GUIDE

HI 904

KARL FISCHER

COULOMETRIC TITRATOR

Revision 1.0



 **HANNA**[®]
instruments

www.hannainst.com

QUICK START GUIDE

Dear customer,

Congratulations on choosing a Hanna Instruments Product.

This guide has been written for the **HI 904** Karl Fischer Coulometric Titrator.

Please read this Quick Start Guide carefully before using the instrument. This guide will provide you with the necessary information for the correct use of the instrument.

The purpose of this guide is to present a quick overview of setting up and using the instrument.

For detailed information illustrating the extensive capabilities of your titrator, please refer to the Instruction Manual.

Hanna Instruments

All rights are reserved. Reproduction in whole or in part is prohibited without the written consent of the copyright owner, Hanna Instruments Inc., 584 Park East Drive, Woonsocket, Rhode Island, 02895, USA.

Contents

INTRODUCTION5

SAFETY MEASURES.....6

TITRATOR CONNECTIONS7

USER INTERFACE8

HOW TO SELECT YOUR LANGUAGE9

HOW TO USE THE CONTEXTUAL HELP9

METHODS9

BEFORE PERFORMING THE FIRST TITRATION.....10

HOW TO PERFORM THE FIRST TITRATION10

INTRODUCTION

The **HI 904** Karl Fischer Coulometric titrator is extremely flexible, capable of performing a wide variety of highly accurate and precise water content titration methods.

The **HI 904** finds a titration endpoint using a polarized electrode and an advanced detection algorithm. A constant flow of current is maintained between the two platinum pins of the titrator's electrode. When the solution in the titration vessel contains water, a relatively large voltage is required to maintain the flow of current between the pins. As the titration proceeds, the water in the sample is consumed by the iodine that is generated electrolytically within the vessel. At the end point, all of the water has been reacted and the cell contains excess iodine. The presence of excess iodine within the titration cell results in a reduction in the amount of voltage required to maintain the constant current between the pins of the electrode. The endpoint detection algorithm incorporated in the **HI 904** analyzes both the electrode response to individual additions of iodine and the shape of the entire titration curve in order to determine the endpoint of the titration.

Titration reports and methods can be transferred to a PC via a USB interface, saved to a USB flash drive or printed directly from the titrator. An external monitor and keyboard can be attached for added convenience.

How can I find certain information?

1. This **Quick Start Guide** will help the user learn how to operate the titrator within a short period of time. The first analysis will be performed with the aid of the factory stored methods.
2. The **Instruction Manual** provides a complete description of the operating principles (user interface, general options, methods, titration mode, maintenance, etc.).
3. The contextual **Help** screens contain detailed explanations about what kind of data can be set or viewed in every displayed screen.
4. The **Titration Theory** booklet outlines the basic concepts of titration.

QUICK START GUIDE

SAFETY MEASURES

The following safety measures must be followed:

1. Never connect or disconnect the pump assemblies with the titrator turned on.
2. Always check that the reagent and waste bottles, as well as the titration vessel are properly assembled.
3. Always wipe up spills and splashes immediately.
4. Avoid the following environmental working conditions:
 - Severe vibrations
 - Direct sunlight
 - Atmospheric relative humidity above 80% non-condensing
 - Environment temperatures below 10°C and above 40°C.
 - Near heating or cooling sources
 - Explosion hazards
5. Have the titrator serviced by qualified service personnel only.
6. Avoid inhalation of reagent vapors. Avoid contact with chemicals.

TITRATOR CONNECTIONS

Front View

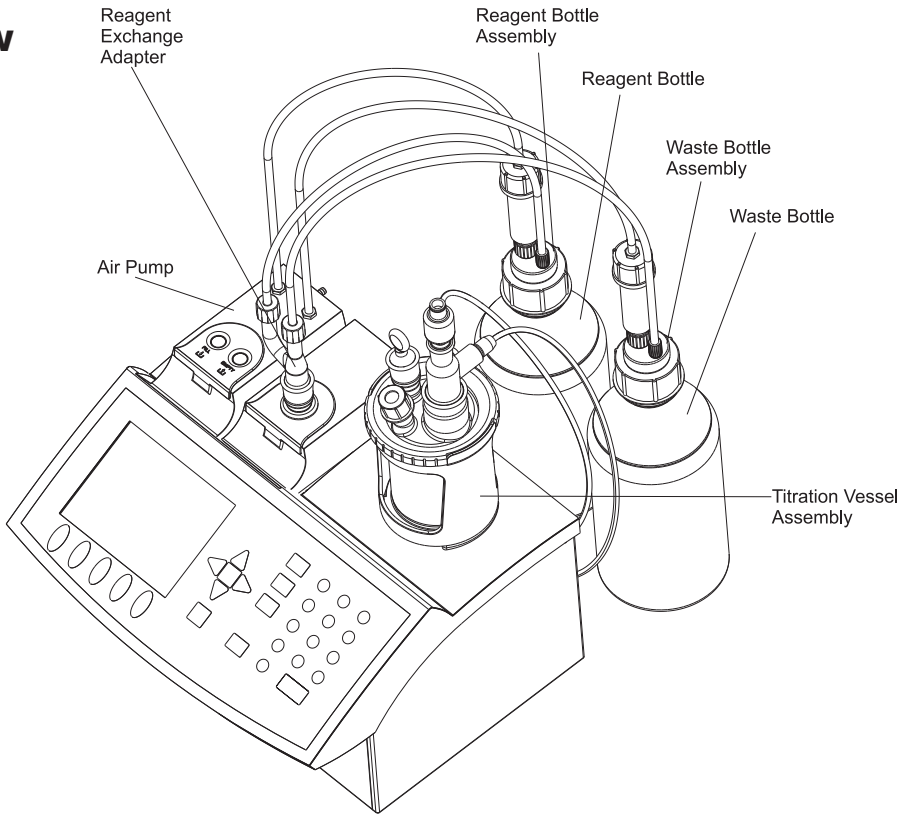

Rear View

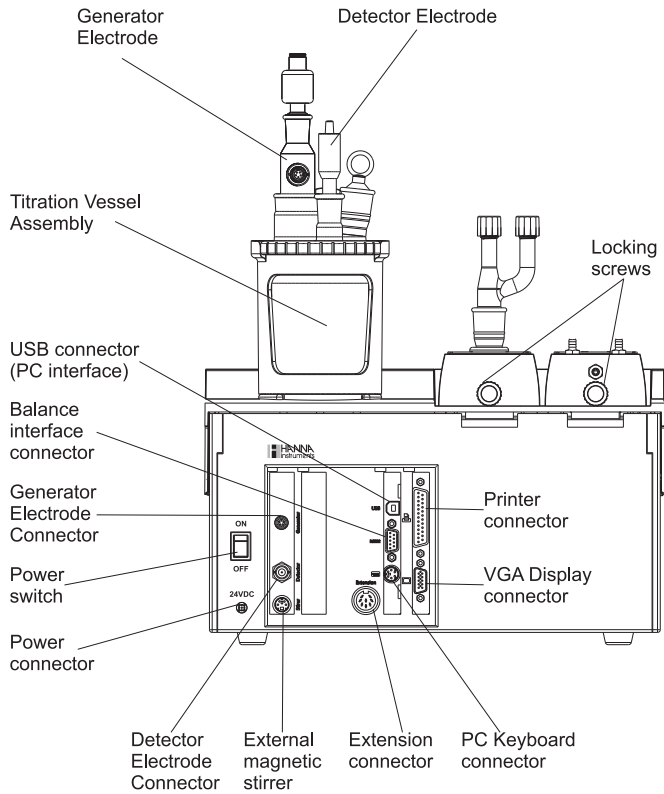

QUICK START GUIDE

USER INTERFACE

Keypad

The titrators have their own keypad with 29 keys grouped in four categories, as follows:

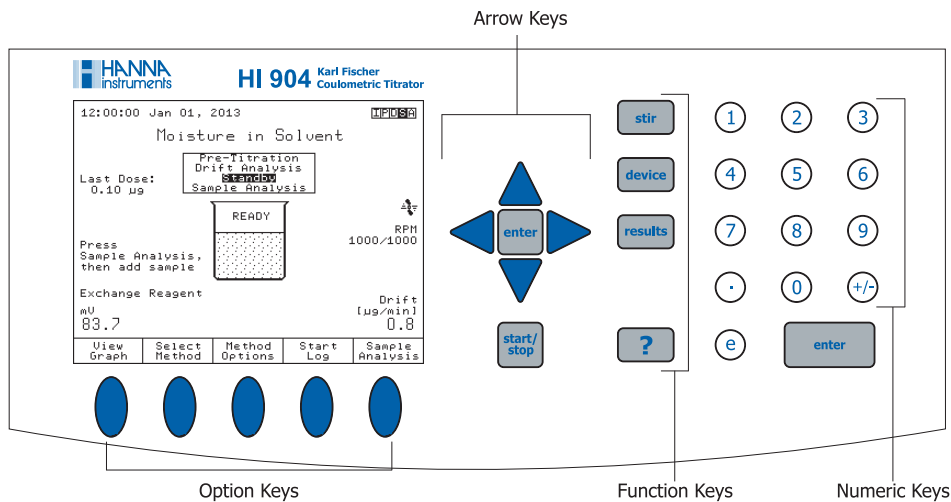

Display



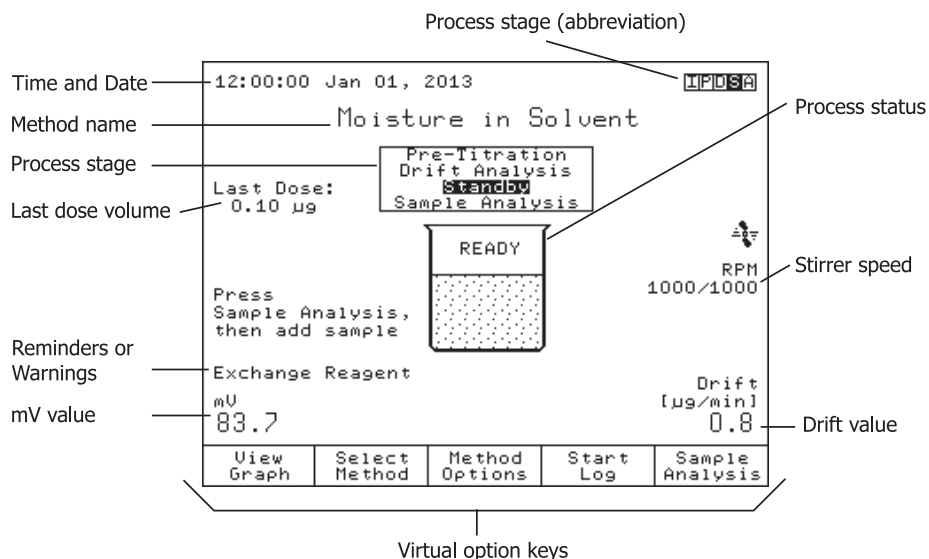

The titrators have a 5.7" graphical backlit color display. The *Standby Mode* screen is shown below with short explanations.



The user interface contains several screens. In each screen, many information fields are present at the same time. The information is displayed in an easy-to-read manner, using different size fonts.

Virtual option keys describe the function performed when the corresponding soft key is pressed.

HOW TO SELECT YOUR LANGUAGE

To change the language, press  from the main screen. Highlight the *Language* option and then press . Using the  and  keys select the language from the options listed in the **Set Language** screen and press . Restart the titrator in order to apply the new language setting.

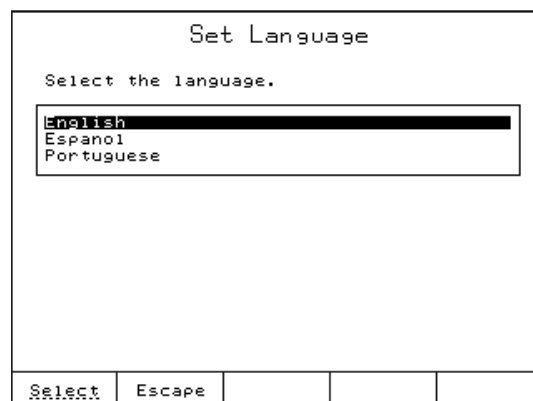

HOW TO USE THE CONTEXTUAL HELP

Any information about the titrator can be easily accessed by pressing . The contextual help can be accessed at any time and it provides useful information about the current screen.

METHODS

The **HI 904** Karl Fischer titrator can store up to 100 methods: these include up to 90 standard methods.

Standard Methods

Each titrator is supplied with a customized package of standard methods. Standard method packs are developed at Hanna Instruments laboratories to meet analysis requirements of specific industries.

User-Defined Methods

User-defined methods allow the user to create and save their own methods. Each new method is typically based on an existing method which is altered to suit a specific application.

QUICK START GUIDE

BEFORE PERFORMING THE FIRST TITRATION

Setup the Titrator

- Make sure that all of the titrator assemblies are properly installed (see Instruction Manual, *Setup* section).
- Make sure that the vessel system is properly sealed against atmospheric moisture (the fittings and tubes are correctly mounted).
- The desiccant had been properly dried.

Obtaining the Reagents





- The reagents have to be suitable to the analysis requirements (see Instruction Manual, *Appendix 2* for list of preferred reagents).

HOW TO PERFORM THE FIRST TITRATION

Method Selection

For this analysis we will use the **HI 9301EN Moisture in Solvent**.

To select this method:







- Press  from the *Idle* screen. Use the  and  keys to highlight the **HI 9301EN Moisture in Solvent** method.
- Press .

After accomplishing these operations, the method's name will be displayed on the top line of the *Idle* screen.

Setup Titration Report



Users can select the information that is stored for each titration that is performed.

To obtain proper information at the end of the titration, perform the following operations:

- From the main screen, press  and the **Data Parameters** screen will be displayed.
- Highlight the *Setup Titration Report* option and press .
- Mark the fields to be included with the "*" symbol using the  and  keys and press  to toggle the selection.
- Press  and then press  to return to the main screen.

Fill Titration Vessel with Reagent

The titration vessel must be filled with reagent up to the MIN marker (about 75 mL):

- Lower the reagent tube below the liquid level inside the reagent bottle.
- From the *Idle* screen, press .
- Push and hold the **FILL** button located on the top of the air pump.
- Wait until the vessel is filled up to the MIN marker with solvent.
- Stop the air pump by pressing  and then confirm the approximate amount of reagent in the vessel.
- Raise the reagent tube above the liquid in the reagent bottle.

Prepare the Reagent for Samples

Before beginning a titration, residual moisture inside the titration vessel and reagent must be reacted:

- From the *Idle* screen, press . The titrator will enter Pre-Titration mode, start the magnetic stirrer, and begin dosing in the titration vessel.
- Once all residual moisture has been reacted (endpoint potential is reached), the titrator will enter Drift Analysis mode (assuming Automatic Drift Entry is selected). The titrator calculates the rate of atmospheric moisture seeping into the titration beaker for the next minute and displays the result in the lower right corner of the display.
- If the Drift Rate is stable and the endpoint potential is maintained, the titrator will enter Standby mode. The titrator continues to maintain the endpoint potential and update the background drift rate.

Note: *New (or cleaned) detector electrodes have low electrical resistance due to a lack of platinum-iodine complexes on the electrode surface. This may cause initial mV readings to be low and prevent proper pre-titration of the reagent. The endpoint value (100 mV by default) should be 200-250 mV below the mV value of "wet" reagent for proper pre-titration to occur. If necessary, adjust the endpoint and/or imposed current (in Method Options) to facilitate proper pre-titration. The platinum-iodine complex should form after several titrations and raise the mV readings.*

Preparing and Introducing the Sample

Sample Mass Preparation

Measuring the sample size by mass using an analytical balance will give the most reproducible results.

QUICK START GUIDE



Liquid Samples:

- Samples with low viscosity will be added using a syringe with needle (injection through the septum).
- Weigh the syringe before and after injection in order to increase precision (back-weighing technique).

Sample Volume Preparation

Liquid samples with low viscosity can be added by volume. Samples should be added using a precision syringe and needle.

Performing a Titration

- From the main screen press  for analyzing a sample. You will be prompted to enter the analyte size. Add a prepared sample according to a preparation method outlined above. Enter the analyte size and press . The titrator will start the analysis according to the selected method.
- At the end of the titration, the message "Titration Completed" will appear on the titration status, together with the final concentration of the moisture in the sample, the end point volume, and other relevant information. The titrator re-enters *Standby* mode (if active) in the background.

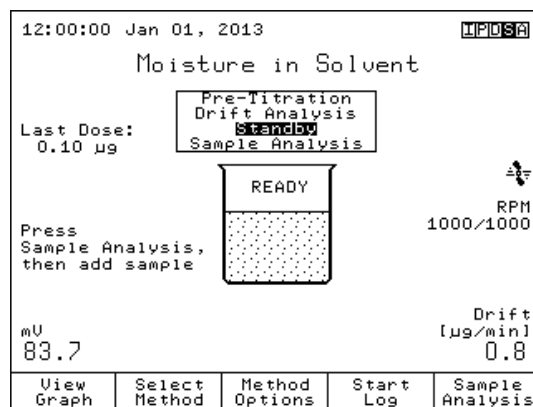

Understanding the Displayed Information

During a titration, the following screen is displayed:

Viewing Graph During Titration

Press View Graph to display the real time titration graph.

The curve displayed is a plot of Electrode Potential vs. Titrated Water.

A dashed horizontal line represents the user selected end point potential.

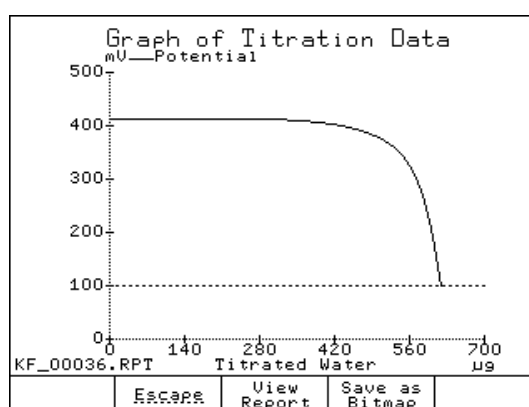
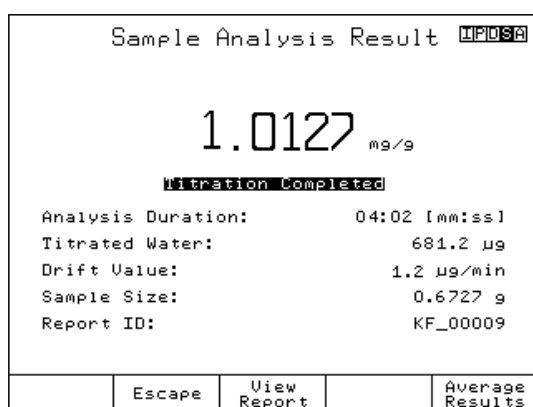

Titration Termination

The titration is terminated when the conditions of the Termination Criteria have been met. The default Termination Criterion is a mV value, in which the titration is terminated after the mV value remains below the end point potential for the selected stability time.

When the titration has ended, the titrator will display the final concentration of the moisture together with the basic titration information.

To view the custom report or titration graph, press View Report.

To view statistics of multiple analyses, press Average Results.

When done, press Escape to return to standby mode (if active).

Results

The results obtained from titration are stored in a report file that can be displayed, transferred to a USB storage device or a PC, or printed.



Viewing the last titration data

- Press results (while no titration is being performed).
- The **Data Parameters** screen will be displayed.
- From the **Data Parameters** screen highlight the *Review Last Titration Report* option and press

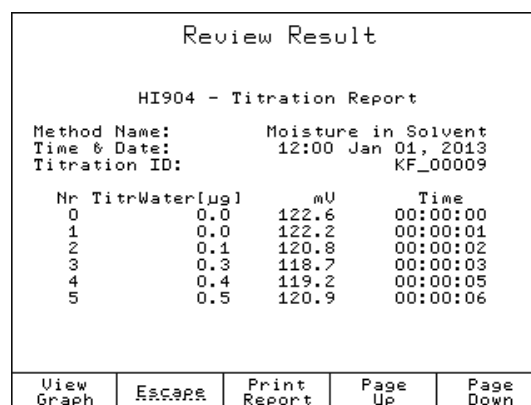
Select.



QUICK START GUIDE



- The **Review Result** screen will be displayed.
- Use the  and  keys to display information related to the last titration performed. See *titration report* on page 15.

Printing the titration report

Connect a DOS / Windows compatible printer directly to the DB 25 connector (parallel port) located on the back of the titrator.





Note: To connect the printer, please turn off the titrator and the printer.

Printing out the report:





- From the **Review Report** screen, press .
- During the information transfer to the printer, the message "Printing" will be displayed on the screen.
- Press  to return to the **Data Parameters** screen.
- Press  again to return to the main screen.

Saving the data on a USB storage device

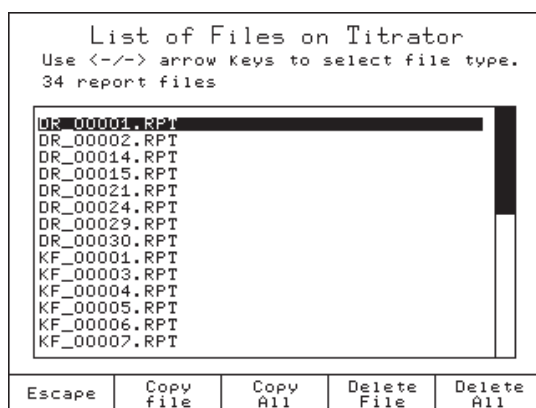
This feature allows saving the results of titrations or drift logging sessions on a USB storage device.

- Insert the USB storage device into the USB socket.
- From the *Idle* screen, press . The **General Options** screen will be displayed.
- Highlight the *Save Files to USB Storage Device* option using the  and  keys.
- Press . The **List of Files on Titrator** screen will be displayed.



- Use the  or  keys to select the file type: "report files".
- Press  to transfer all available reports to USB storage device, or highlight the name of the report file to be transferred and press .

- Transferring a report file will automatically transfer the corresponding log file and titration graph BMP file (if applicable).
- Press Escape, to return to the **General Options** screen.
- Press Escape again, to return to the *Idle* screen.

Titration report

While scrolling with the Page Up and Page Down keys, the fields below can be seen on the titrator display or printed. The same information is available on the saved report file (KF_00003.rpt in this example, with all report fields selected).

HI904 - Titration Report

Method Name: Moisture in Chloroform
Time & Date: 15:15 Jul 28, 2013
Titration ID: KF_00003
Company Name: Hanna Instruments
Operator Name: KF Technician
Electrode Name: Probe 1
Field 1: Any text
Field 2: Any text
Field 3: Any text
Titrator Software Version: v1.00
Base Board Software Version: v3.00
Titrator Serial Number: 04132903
Analog Board Serial Number: 33121212
Analog Calibration Date: Jul 18, 2013

Method Parameters

Name: Moisture in Chloroform
Method Revision: 1.0
Type: KF Coulometric
Pre-Analysis Stir Time: 5 Sec
Stirring Speed: 900 RPM
Stirbar Type: Medium
Drift Entry: Automatic
Reagent: General Purpose

Sample Parameters:

Sample Determ.: Normal
Sample Name: Chloroform
Sample Type: Mass
Sample Size: 2.8101 g

Control Parameters:

Titration Speed: Auto
Standby Mode: Enabled
Standby Duration: 72:00 [hh:mm]
Imposed Current: 2 A
End Point Value: 100.0 mV
Generator Current Mode: Auto
Signal Averaging: 2 Readings

Termination Parameters:

Maximum Duration: 1200 sec
Maximum Titrated Water: 10.0 mg
Term. Criterion: Relative Drift
Relative Drift: 3.0 µg/min

Result Unit: ppm

QUICK START GUIDE

Nr	Titration	Water[μ g]	mV	Time
0		0.0	385.7	00:00:00
1		0.0	385.7	00:00:01
2		1.5	385.8	00:00:02
3		3.0	385.7	00:00:04
4		4.5	385.4	00:00:05
5		6.0	385.5	00:00:06
6		7.5	385.8	00:00:07
7		8.9	385.3	00:00:08
8		11.2	385.3	00:00:09
9		13.4	386.0	00:00:10
10		15.7	386.8	00:00:11

27		62.8	385.0	00:00:29
28		65.8	384.7	00:00:30
29		68.7	383.7	00:00:31
30		71.6	383.9	00:00:32
31		74.6	385.3	00:00:33
32		77.5	384.8	00:00:34
33		80.5	384.3	00:00:35
34		83.4	383.5	00:00:36
35		86.3	382.9	00:00:37
36		89.3	382.2	00:00:38
37		92.2	381.0	00:00:39
38		95.1	380.1	00:00:40
39		98.1	380.1	00:00:41
40		101.0	379.4	00:00:42
41		104.0	377.8	00:00:43
42		106.9	376.1	00:00:44

66		140.8	101.0	00:01:09
67		141.2	94.1	00:01:10
68		141.2	91.2	00:01:12
69		141.2	89.9	00:01:13
70		141.2	88.8	00:01:14
71		141.2	88.1	00:01:15
72		141.2	87.7	00:01:16
73		141.2	87.9	00:01:17

93		141.2	89.5	00:01:38
94		141.2	89.3	00:01:39
95		141.2	89.0	00:01:40
96		141.2	88.9	00:01:41
97		141.2	89.1	00:01:42
98		141.2	88.8	00:01:43
99		141.2	88.8	00:01:44
100		141.2	88.9	00:01:45
101		141.2	88.8	00:01:46
102		141.2	88.8	00:01:47

Titration Results

Method Name: Moisture in Chloroform
Time & Date: 14:35 Jul 26, 2013
Sample Size: 2.3140 g
Drift Value: 0.3 μ g/min
Titrated Water: 141.21 μ g
Result: 60.7 ppm
Titration Duration: 02:37 [mm:ss]
Generator Electrode Type: HI900511
Titration went to Completion
Operator Name: Any text

Analyst Signature: _____

QS 904
08/13

INSTRUCTION MANUAL

HI 904

KARL FISCHER

COULOMETRIC TITRATOR

Revision 1.00

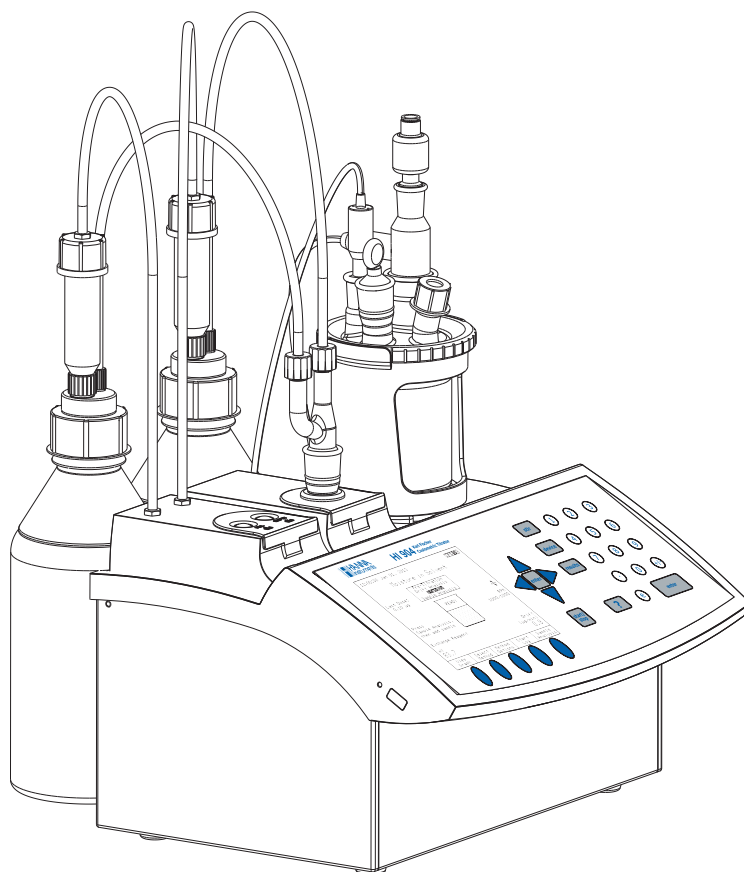

 **HANNA**[®]
instruments

www.hannainst.com

Dear customer,

Congratulations on choosing a Hanna Instruments product.

Please read this instruction manual carefully before using the instrument. This manual will provide you with the necessary information for the correct use of the instrument.

Hanna Instruments

All rights are reserved. Reproduction in whole or in part is prohibited without the written consent of the copyright owner, Hanna Instruments Inc., 584 Park East Drive, Woonsocket, Rhode Island 02895, USA.

TABLE OF CONTENTS

- Chapter 1. INTRODUCTION**
 - Chapter 2. SETUP**
 - Chapter 3. USER INTERFACE**
 - Chapter 4. GENERAL OPTIONS**
 - Chapter 5. METHODS**
 - Chapter 6. TITRATION**
 - Chapter 7. AUXILIARY FUNCTIONS**
 - Chapter 8. MAINTENANCE, PERIPHERALS**
 - Chapter 9. OPTIMIZATION**
 - Appendix 1. TECHNICAL SPECIFICATIONS**
 - Appendix 2. RECOMMENDED REAGENTS**
 - Appendix 3. TITRATOR COMPONENTS**
-

1 INTRODUCTION

The **HI 904** is an automatic coulometric Karl Fischer titrator with high accuracy, great flexibility and repeatability.

The titrator is designed to perform titrations for a variety of applications.

The main attributes of this titrator are:

Flexibility	Support up to 100 titration methods (standard and user defined).
High accuracy	Precise pulsing coulometric generator. Precise mV measurement and current (μA) control.
Repeatability	Powerful built-in algorithms for termination criteria based on fixed mV endpoint or absolute/relative drift.
Quick results	Pre-defined titration methods. Variable titration speed for improved accuracy. Balance interface for automatic weighing.
Complete report	Results are displayed directly in the selected units along with the titration information. Titration graph can be displayed on the LCD and saved as a bitmap. Customizable titration reports and drift analysis reports can be printed, saved on a USB storage device or transferred to a PC via the USB interface.
Result history	Averaging and statistical data available for sample analysis.
GLP features	Exchange Reagent reminder. Fields for specific annotations.
Conditioning phase	Automatic pre-titration for drying the reagent and titration vessel. Drift analysis-adjusted titration results for improved accuracy.
Sealed solvent system	Allows full operation in a completely sealed system, minimizing water vapor entry.
Self diagnosis and integrated help	Integrated help screens are available. Self diagnosis features for peripheral devices including air pump and stirrer. Error management with warning and error messages.
Large graphical display	5.7" (320 x 240 pixels) graphical color display with backlight. Easy to view text and graphs. User friendly interface.

This manual provides information regarding installation and functionality of the titrator and refined operation suggestions.

Before using the titrator, it is recommended you become familiar with its various features and functionality.

Chapter 2. Contents

2	SETUP	2 - 3
2.1	Unpacking	2 - 3
2.2	Safety Measures	2 - 4
2.3	Installation	2 - 5
2.3.1	Titrator Top View	2 - 5
2.3.2	Titrator Rear View	2 - 6
2.3.3	Titrator Left-side View	2 - 6
2.3.4	Titrator Assembly	2 - 7
2.3.4.1	Connecting the Air Pump	2 - 7
2.3.4.2	Connecting the Reagent Adapter Holder	2 - 8
2.3.4.3	Titration Vessel	2 - 9
2.3.4.3.1	Titration Vessel Components	2 - 10
2.3.4.4	Electrical Connections	2 - 12
2.3.5	Reagent, Waste Bottle Assembly	2 - 13
2.3.6	Reagent Exchange Adapter	2 - 14

2 SETUP

2.1 Unpacking

The titrator and the accessories are shipped in a single box containing:

ITEM	QUANTITY
1 Titrator	1 pc.
2 Air Pump Assembly	1 pc.
3 Titration Vessel Assembly	1 pc.
• Glass Vessel	
• Accessory Port Stopper	
• Sample Port Cap and Septum	
• Stir Bar	
• Desiccant	
• Desiccant Cartridge	
• Fittings, O-rings	
4 Vessel Support with Adapter	1 pc.
5 Pump Locking Screw with Plastic Head	2 pcs.
6 Reagent Bottle Assembly	1 pc.
• Bottle Cap	
• Desiccant	
• Desiccant Cartridge	
• Fittings, O-rings	
• Tubes (Silicone and PTFE Tubing)	
7 Waste Bottle Assembly	1 pc.
• Waste Bottle	
• Bottle Cap	
• Desiccant	
• Desiccant Cartridge	
• Fittings, O-rings	
• Tubes (Silicone and PTFE Tubing)	
8 Calibration Key	1 pc.
9 Karl Fischer Dual Platinum Pin Detector Electrode	1 pc.
10 Reagent Exchange Adapter	1 pc.
11 Accessory Holder Assembly	1 pc.
12 Joint grease	1 pc.
13 Karl Fischer Generator Electrode	1 pc.
• Removeable Generator Electrode Cable	

SETUP

14	Power Adapter	1 pc.
15	USB Cable	1 pc.
16	Instruction Manual Binder	1 pc.
17	USB Storage Device	1 pc.
18	HI 900 PC Application (Install Kit on USB Stick)	1 pc.
19	Quality Certificate	1 pc.

See **Appendix 3** section **A 3 Titrator components** for pictures.

If any of the items are missing or damaged, please contact your sales representative.

Note: *Save all packing materials until you are sure that the instrument functions correctly. Any damaged or defective items must be returned in their original packing materials together with the supplied accessories.*

2.2 Safety Measures

The following safety measures must be followed:

1. Never connect or disconnect the air pump assembly with the titrator turned on.
2. Always check that the reagent and waste bottles and the titration vessel are properly assembled.
3. Always wipe up spills and splashes immediately.
4. Avoid the following environmental working conditions:
 - Severe vibrations
 - Direct sunlight
 - Atmospheric relative humidity above 80% non-condensing
 - Environment temperatures below 10°C and above 40°C
 - Explosion hazards
5. Have the titrator serviced only by qualified service personnel.

2.3 Installation

2.3.1 Titrator Top View

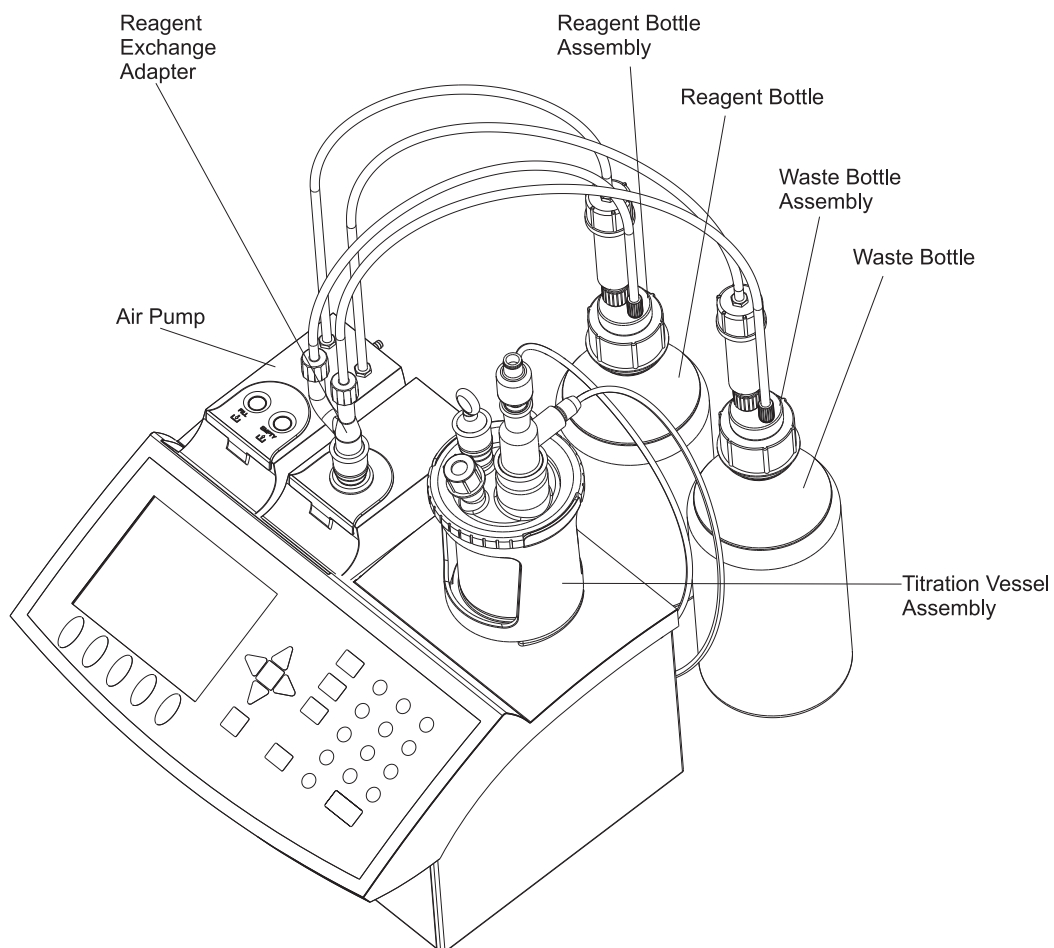

SETUP

2.3.2 Titrator Rear View

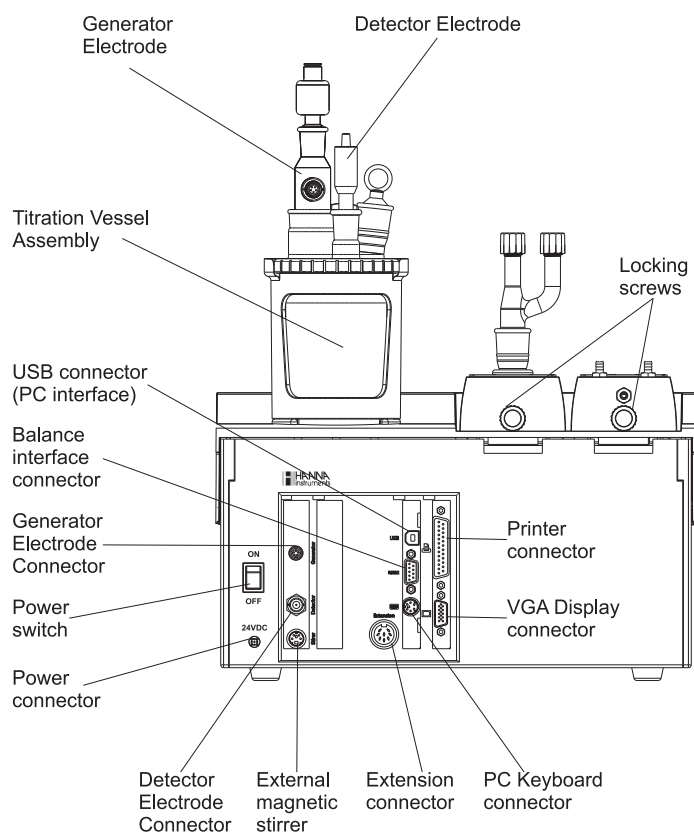

2.3.3 Titrator Left-side View

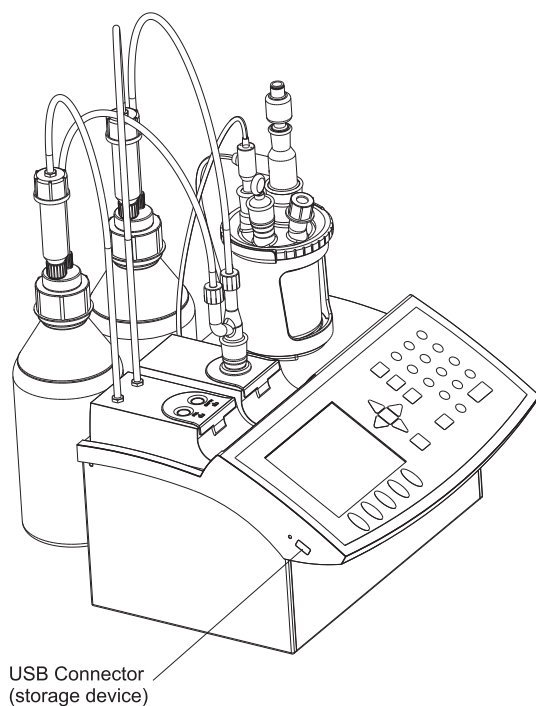

2.3.4 Titrator Assembly

Note: Assembly operations must be completed before connecting the titrator to the power supply!

2.3.4.1 Connecting the Air Pump

The diaphragm air pump system is designed to work with the specially designed bottle top assemblies. It allows the reagent in the titration vessel to be removed and/or replaced with minimal exposure of the interior of the vessel to ambient moisture from atmospheric humidity. Connect the air pump with the following steps (see Figure 1):

- (1) Retrieve the air pump cable (PUMP 1) from inside the left bay. Connect the cable to the air pump as shown in Figure 1. The air pump connector is located on the left side of the motor.
- (2) Lower the pump into the titrator, then slide it towards the front of the titrator chassis until it is firmly latched.
- (3) Secure the pump with the locking screw.

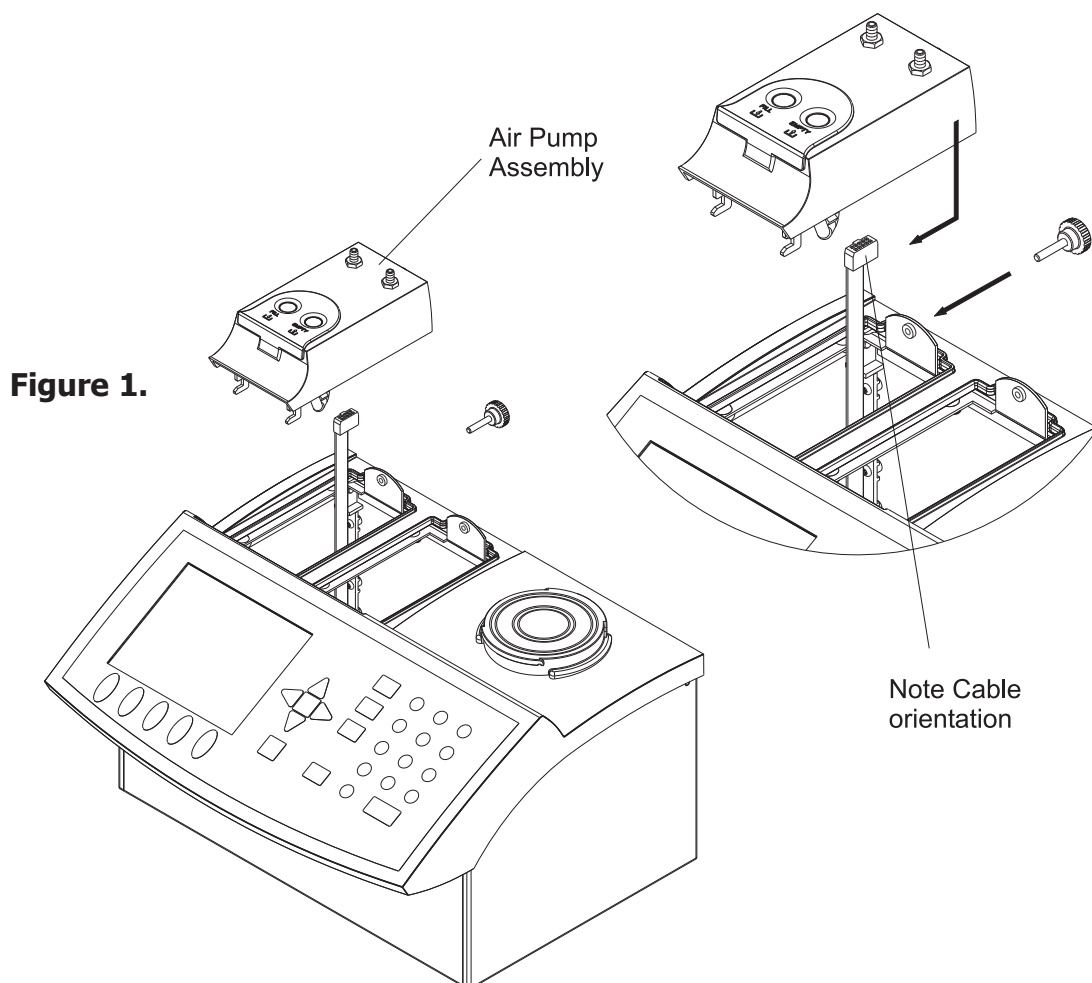

2.3.4.2 Connecting the Reagent Adapter Holder

The Reagent Adapter Holder is a convenient dock for the Reagent Exchange Adapter when it is not in use. The holder consists of a base that fastens to the titrator pump bay and a removable standard-taper glass tube. The glass tube holds the Reagent Exchange Adapter and will catch possible drips from the reagent/waste tubes. It is easily removable for cleaning purposes. Install the Reagent Adapter Holder with the following steps (see Figure 2.):

- (1) Lower the Reagent Adapter Holder base into the right bay, then slide it towards the front of the titrator chassis until it is firmly latched.
- (2) Secure the base with the locking screw.
- (3) Insert the glass tube into the hole in the base. If the tube does not slide easily into the holder, apply a small amount of glass joint grease (included) to the outside of the tube for lubrication.

Figure 2

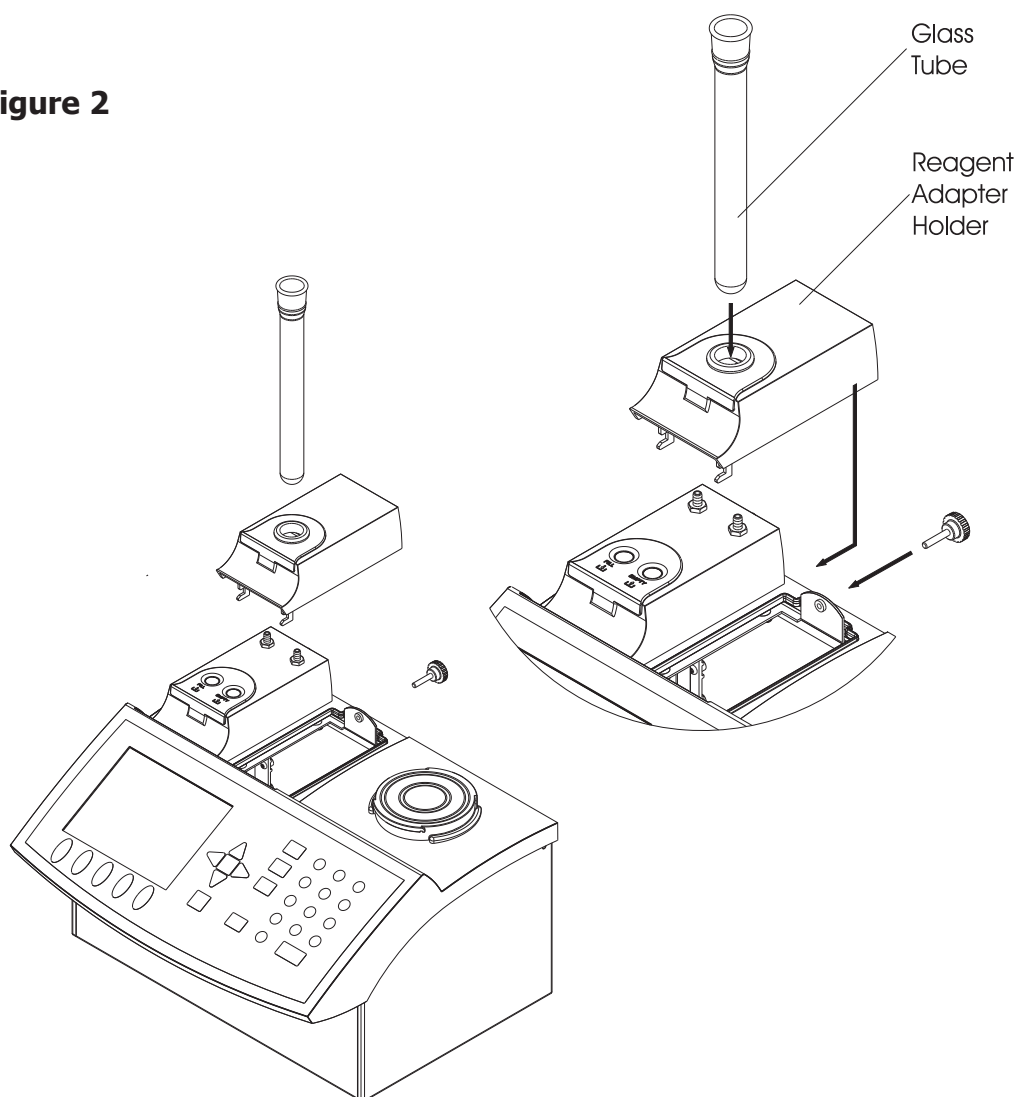

Note: To set up the Reagent Exchange Adapter, see Section 2.3.6.

2.3.4.3 Titration Vessel

The titration takes place in a sealed titration vessel. The titration vessel can also be referred to as a reaction vessel, titration cell or reaction cell.

The primary design features of the **HI 904** titration vessel include the following:

- Durability, easy to use, clean and maintain.
- All glass cells are manufactured with ground-glass joints for ultra-low water vapor permeability and high chemical resistivity to Karl Fischer reagents.
- A sample port with open-top screw cap for easy septum replacement.
- A desiccant cartridge containing molecular sieves to dry the ambient air which enters the cell as reagent and sample are added/removed from the titration vessel.
- Electrode port for generators with and without diaphragm.

To attach the titration vessel, see Figure 3 and follow the steps below:

- Align the vessel support (D) with the base plate and attach by rotating clockwise.
- Insert the support adapter (C) onto the vessel support (D) while aligning the notches. If the o-ring (B) is not installed, insert it into the inner groove of the support adapter (C).
- Lower titration vessel into the vessel support (D) by gently pushing it through the support adapter (C).

Figure 3

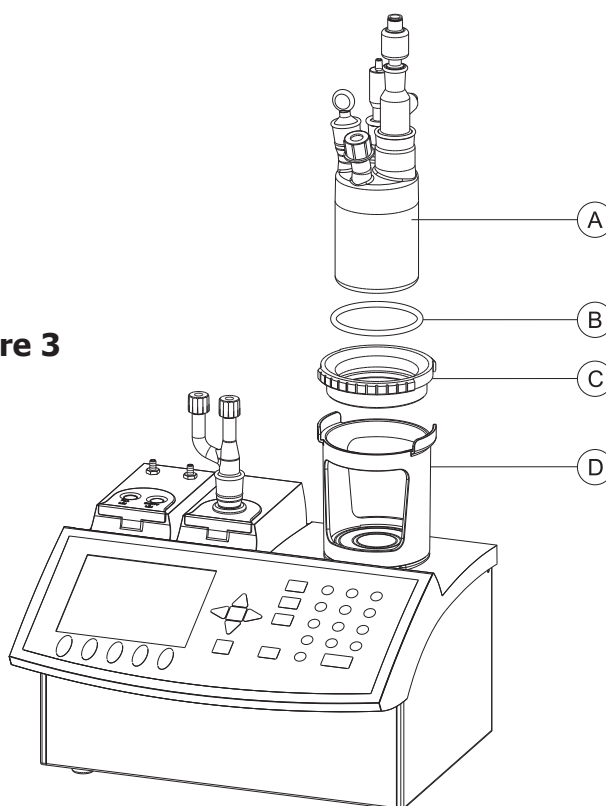

SETUP

2.3.4.3.1 Titration Vessel Components

Warning: Always apply a thin layer of joint grease (supplied) to ground-glass joints before attaching. Improperly-greased joints may become permanently seized!

To assemble the titration vessel, see Figure 4 and follow the steps below:

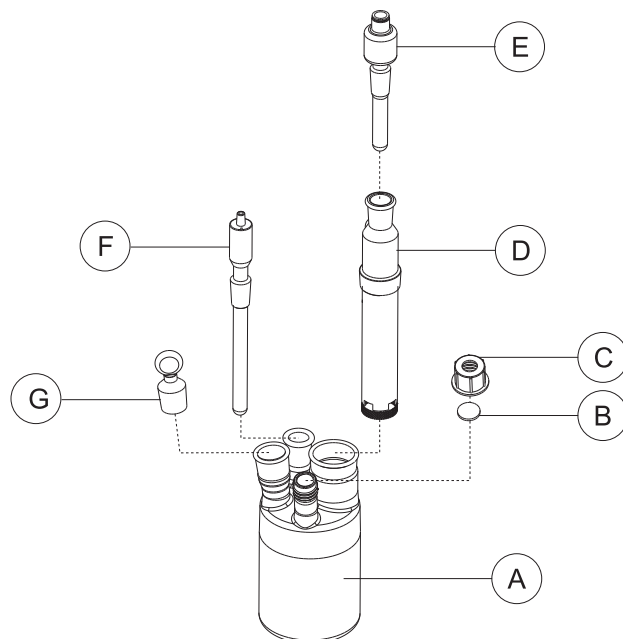

Figure 4

Karl Fischer Detector Electrode

The Karl Fischer detector electrode (F) consists of two parallel, platinum pins sealed into a 10mm diameter glass body. Two steel pins connect the platinum elements to a standard BNC connector, which allows for easy attachment to the **HI 904**.

Attach to the titration vessel (A) in the dedicated ground-glass port.

Karl Fischer Generator Electrode

The Karl Fischer generator electrode (D) consists of two platinum electrodes (anode and cathode) on a glass body. The anode and cathode may be separated by a diaphragm that is built into the body of the generator. The **HI 904** can be used with both diaphragm and diaphragm-less generators.

Attach the generator electrode (D) to the titration vessel (A) in the dedicated ground-glass port.

Desiccant Cartridge

The desiccant cartridge (E) provides a dry path for pressure equalization between the ambient air and the inside of the titration vessel.

Attach the desiccant cartridge (E) to the top of the generator electrode (D) in the dedicated ground-glass port.

Reagent Exchange Port

The **HI 904** titration vessel can be connected to the reagent and waste bottles using the Reagent Exchange port and the supplied adapter. The Reagent Exchange Adapter may remain connected to the titration vessel during operation if lower drift is not necessary. Otherwise, place the supplied glass stopper (G) in the Reagent Exchange Port.

Sample Port

The sample port consists of a silicone rubber septum (B) secured in place with an open-top GL18 cap (C). This allows liquid samples to be added to the titration vessel with a syringe and needle while sealing the vessel from atmospheric moisture. The rubber septum can be easily replaced as needed by removing the GL18-threaded cap.

SETUP

2.3.4.4 Electrical Connections

- Connect the KF generator electrode to the 5-pin connector (C) using the supplied cable.
- Connect the KF detector electrode to the BNC connector (D).
- Connect the power adapter cable to the power input connector (B).

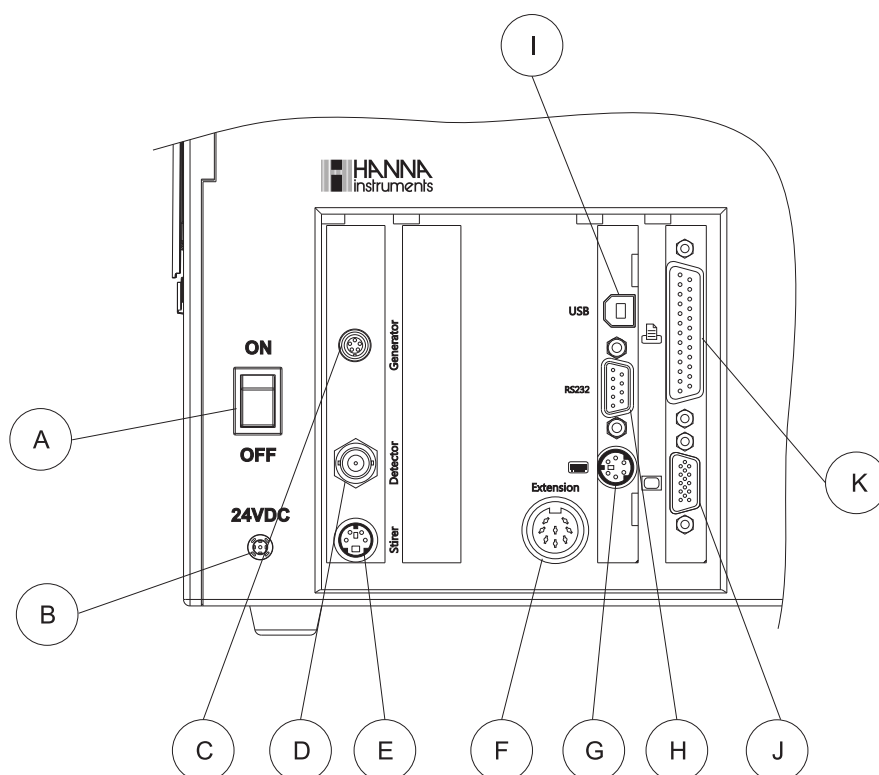

Figure 5

	Function	Type of Connector
A	Power switch	
B	Power input connector (24 Vdc)	DC Power jack connector
C	Generator electrode output	5-pin connector
D	Detector electrode input	BNC socket
E	External magnetic stirrer	4-pin mini DIN
F	Extension connector	8-pin DIN socket
G	PC keyboard connector	6-pin mini-DIN (Standard PS2)
H	Balance interface connector (RS232)	Standard DE-9 socket
I	USB connector	USB Standard B
J	VGA display connector	Standard VGA display 15-pin socket
K	Printer connector	Standard DB-25 socket

2.3.5 Reagent, Waste Bottle Assembly

The bottle top assemblies are equipped with desiccant cartridges containing molecular sieves, which ensures that the air passing through the reagent handling system has been dried. *The molecular sieves have a limited capacity to absorb moisture and is typically exhausted after 3 to 5 weeks. Molecular sieves, indicating or otherwise, can be regenerated at 300°C.*

The bottle tops are constructed of PTFE and have been designed to accommodate reagent bottles with GL-45 type threaded tops.

The waste and reagent bottle top assemblies include blue PTFE tubing for the handling of liquid Karl Fischer reagent and a clear flexible silicone based tubing for use with the air pump.

Caution: Most Karl Fischer reagents give off harmful vapors. Consult manufacturer's MSDS for safe handling guidelines.

To assemble the reagent or waste bottle, see Figure 6 and follow the next steps:

- Insert a PTFE top (J) into a GL45 cap (E).
- Screw on the desiccant cap with hose barb (F).
- Insert a desiccant cartridge (B) with hose-barbed cap (A) through a 10-mm fitting (F) and 10-mm o-ring (G).
- Insert and screw the desiccant fitting into the corresponding hole. Fasten the desiccant cartridge assembly to PTFE top (J) with 10-mm fitting (F).
- Insert the reagent / waste tube (D) in the 5-mm fitting (H) and attach the o-ring (I).
- Insert and screw the tube fitting into the corresponding hole.
- Screw GL45 (E) cap with full assembly onto reagent bottle.
- Add the air tube (C) to the desiccant cap (A) and connect it to the corresponding position on the air pump. The "Fill" position connects to the reagent bottle assembly. The "Empty" position connects to the waste bottle assembly.

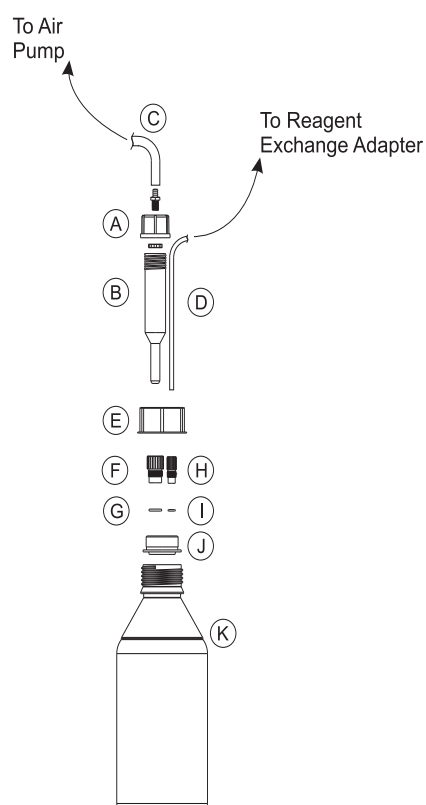
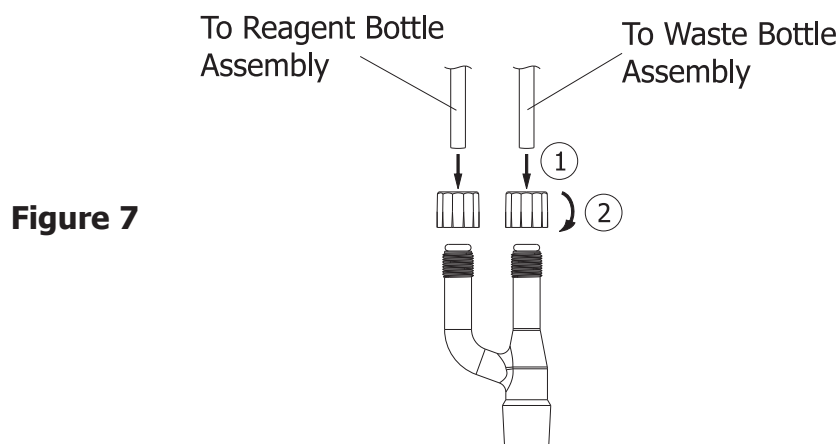

Figure 6

2.3.6 Reagent Exchange Adapter

The Reagent Exchange Adapter is used to connect reagent and waste bottles to the titration vessel. The adapter consists of a set of o-rings and compression caps that form a seal around the reagent and waste tubes, and a ground-glass joint for connection to the titration vessel. The compression caps can be loosened when inserting tubes or adjusting the tube position and tightened to hold the tubes in place. To set up the Reagent Exchange Adapter (see Figure 7):

- (1) Loosen the compression caps on the Reagent Exchange Adapter so that the o-rings uncompress.
- (2) Slide the blue PTFE reagent tube (from the reagent bottle assembly) through the cap and o-ring on the right-angle side of the Reagent Exchange Adapter. At least 1 inch of tube should be inside the adapter.
- (3) Tighten the cap until the reagent tube is held in place.
- (4) Slide the blue PTFE waste tube (from the waste bottle assembly) through the cap and o-ring on the straight side of the Reagent Exchange Adapter. At least 1 inch of tube should be inside the adapter.
- (5) Tighten the cap until the waste tube is held in place.
- (6) Place the Reagent Exchange Adapter into the holder.



Chapter 3. Contents

- 3 USER INTERFACE 3 - 3**
- 3.1 Start Up 3 - 3**
- 3.2 Description 3 - 4**
 - 3.2.1 Keypad 3 - 4
 - 3.2.1.1 Function Keys 3 - 4
 - 3.2.1.2 Option Keys 3 - 4
 - 3.2.1.3 Arrow Keys 3 - 5
 - 3.2.1.4 Numeric Keys 3 - 5
 - 3.2.1.5 Enter Key 3 - 5
 - 3.2.2 Display 3 - 5
 - 3.2.3 The Idle Screen 3 - 6
 - 3.2.4 The Process Screen 3 - 7
- 3.3 Menu Navigation 3 - 8**
 - 3.3.1 Selecting an Option 3 - 8
 - 3.3.2 Selecting a Menu Item 3 - 8
 - 3.3.3 Entering Text 3 - 8
 - 3.3.4 Saving Modifications 3 - 9

3 USER INTERFACE**3.1 Start Up**

Once the instrument is assembled and installed, follow the steps below to start the titrator:

- Connect the instrument to a power outlet with the supplied power adapter.
- Turn on the titrator using the power switch located on the back of the instrument.
- Wait until the titrator finishes the initialization process.
- Press when prompted or wait a few seconds for titrator to start.

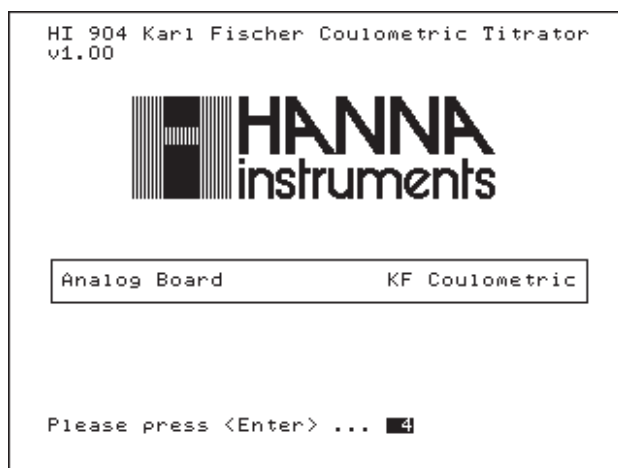

Note: All the performed initialization processes must be successfully completed. If one of the processes is terminated by a "Failed" message, restart the titrator using the power switch. If the problem persists, contact your sales representative.

USER INTERFACE

3.2 Description

This chapter describes the basic principles of navigation through the user interface, selecting fields and entering values from the keypad.

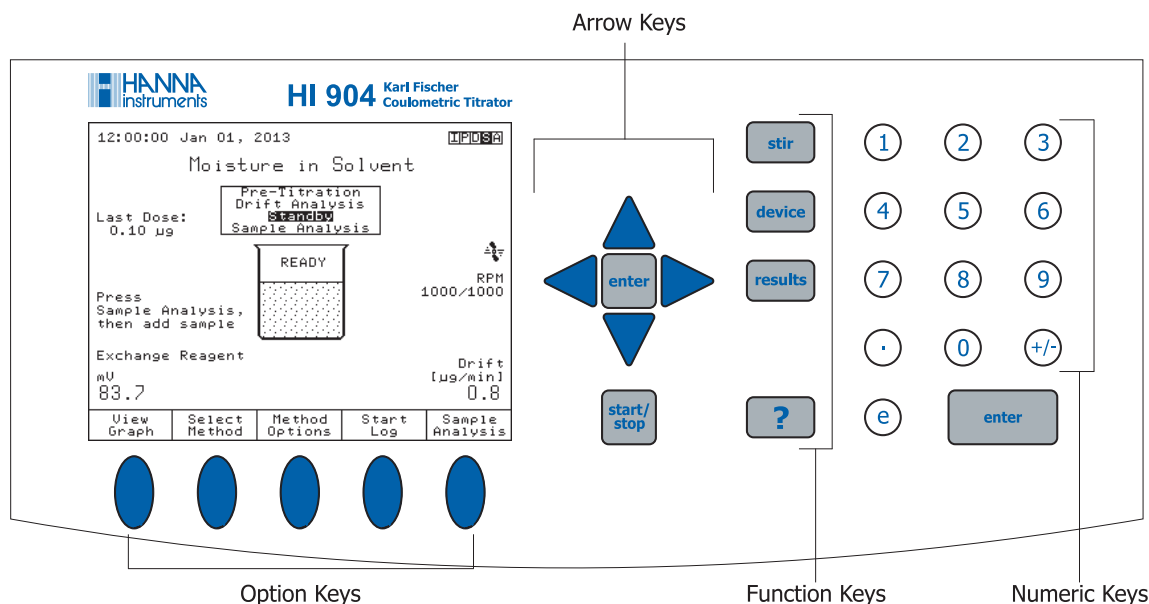





3.2.1 Keypad

The titrator's keypad is grouped into five categories, as follows:

3.2.1.1 Function Keys

If one of these keys is pressed, the associated function is immediately performed. Some of the keys are only active in specific screens:

-  Starts or stops titration sequence
-  Turns the stirrer ON and OFF (*Idle* mode only)
-  Reserved
-  Access the results menu
-  Displays contextual Help

3.2.1.2 Option Keys

These keys are assigned to the virtual keys on the display. Their functions are listed in the boxes above the buttons and vary depending on the displayed screen.

An underlined virtual key can also be activated by pressing .

3.2.1.3 Arrow Keys

These keys have the following functions:

- Move the on-screen cursor.
- Increase and decrease the stirrer speed and other settings.
- In the alphanumeric screen, to select a character.
- To navigate through menu options.

3.2.1.4 Numeric Keys

- Keys 0 to 9 Used for numeric entries.
- +/- Toggles between positive and negative values.
- . Decimal point.
- e Initiates entry of exponent for scientific notation.

3.2.1.5 Enter Key

Both ,  keys perform the same functions:

- Accepts alphanumeric data entry.
- Executes the default (underlined) virtual option key.

3.2.2 Display

The titrator has a large color graphical display. The standby mode screen is shown below with short explanations of the screen segments.

The user interface contains several screens for each titrator function.

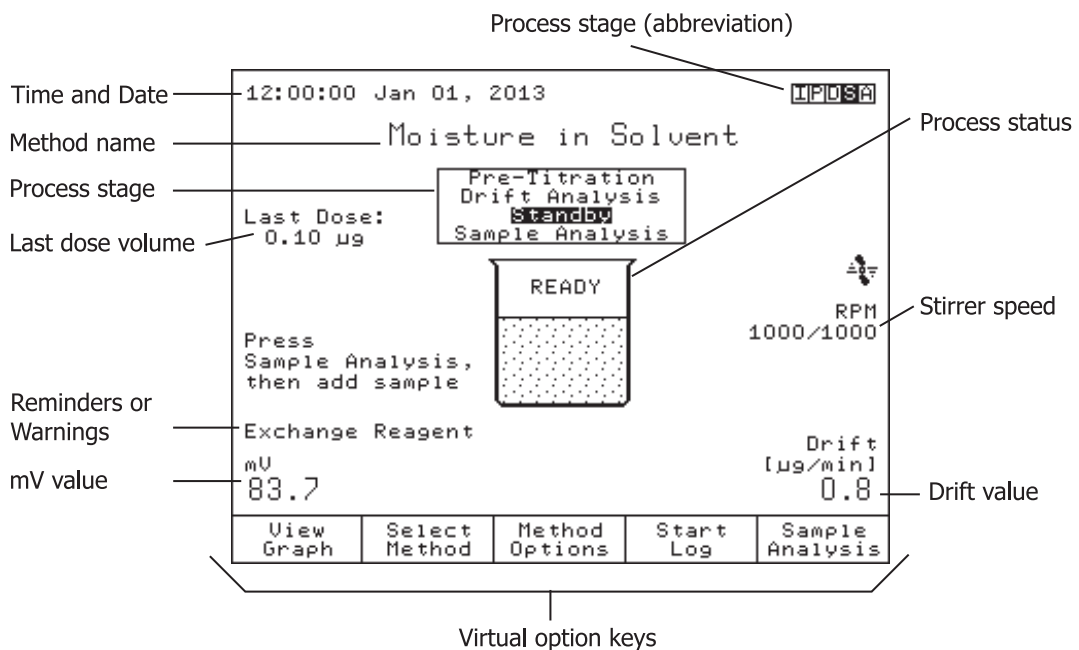

USER INTERFACE

3.2.3 The Idle Screen

After start up and initialization, the first screen displayed is the *Idle Screen*. Idle Screen fields:

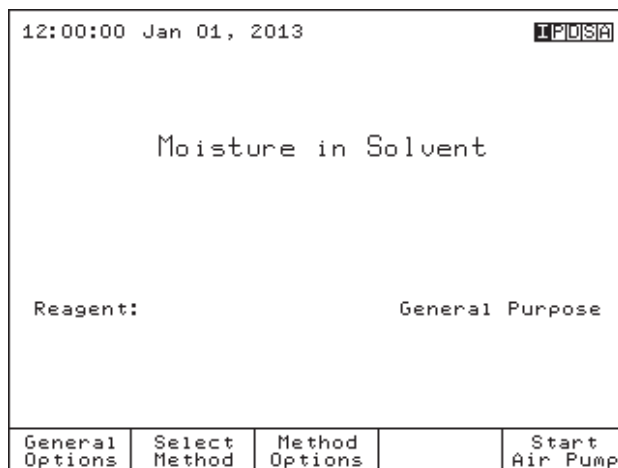

- Method name:** Displays the name of the selected method.
- Time and date:** Displays the current date and time.
- Stirrer information:** Actual / Set stirrer speed is displayed in RPM. When stirrer is off, the stirrer information is not displayed.
- Reagent:** Displays the name of the current reagent.
- Reminders:** Indicates when a task needs to be performed and displays error or warning messages.

3.2.4 The Process Screen

When the user presses  while in *Idle Screen*, all titration related processes are started. The titrator displays the *Process Screen*.

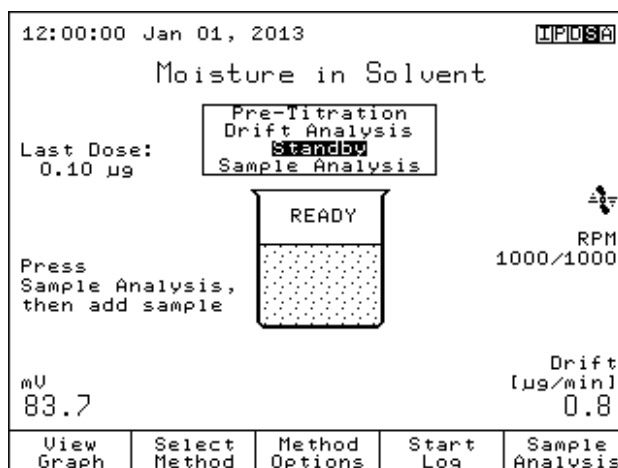

Process Screen fields:

- Method name:** Displays the name of the selected method.
- Time and date:** Displays the current date and time
- Process stage field:** Displays the current process (Pre-titration, Drift Analysis, Standby, Sample Analysis).
- Process status:** Displays the process status with a descriptive drawing.
- mV reading:** Displays the KF electrode potential.
- Last dose:** Displays the last generated dose, in µL water.
- Drift value:** Displays the drift value (when available).
- Stirrer information:** Actual / Set stirrer speed is displayed in RPM.
- Reminders:** Indicates when a task needs to be performed and displays error or warning messages.

USER INTERFACE

3.3 Menu navigation

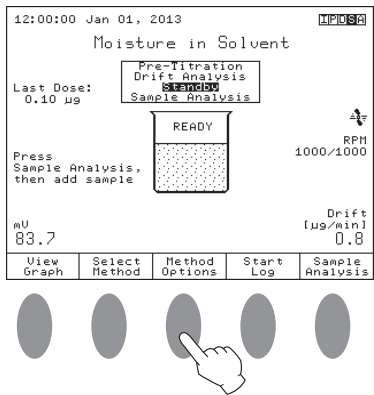

3.3.1 Selecting an Option

To select an option, simply press the option key below the virtual key. For example, to access the **Method Options** screen press the option key below it.

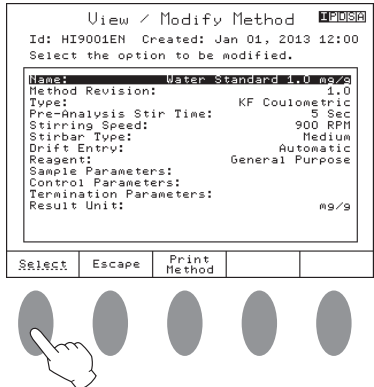

3.3.2 Selecting a Menu Item

To select an item from the menu screen use the arrow keys \triangle and ∇ to move the cursor.

When the menu is larger than the display, a scroll bar is active on the right side. The and keys can be used to scroll through the pages.

To activate the selected menu item, press or .

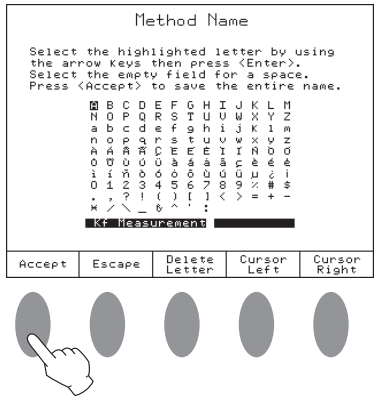

3.3.3 Entering Text

To enter text in an alphanumeric input box, first erase the previous text by using .

To enter a letter, highlight it using the arrow keys then press . Use the same procedure to enter the whole name.

For editing, use the and keys.

When editing is complete, press . Press to return to the previous screen without saving the changes.

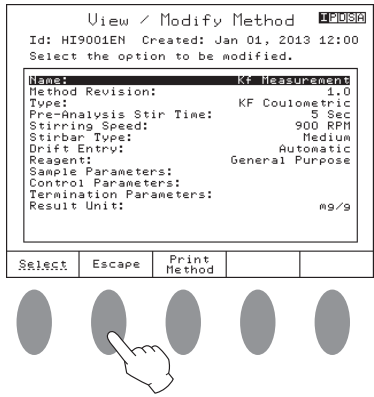

The method name will be updated and displayed in the name field of the **View/Modify Method** screen.

When all the desired parameters have been set, press .

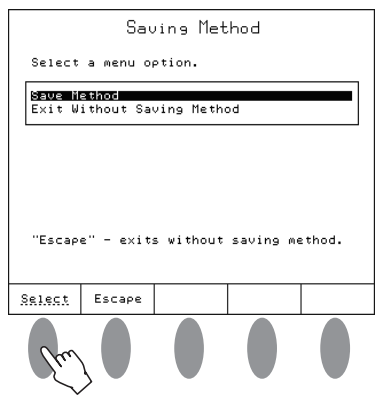

3.3.4 Saving Modifications

The **Saving Method** screen allows the user to save the modifications. To exit from **Saving Method** screen without saving, press **Escape** or highlight the *Exit Without Saving Method* option and then press **Select**. To save the modifications highlight the *Save Method* option and then press **Select**.

Note: To access the contextual help menu, press **?** at any time. Help is related to the displayed screen. Press **Escape** or press **?** again to return to the previous screen.

Chapter 4. Contents

4	GENERAL OPTIONS	4 - 3
4.1	Date and Time Setting	4 - 3
4.2	Display Settings	4 - 4
4.3	Beeper	4 - 5
4.4	Stirrer	4 - 5
4.5	Language	4 - 6
4.6	Reagent Exchange Reminder	4 - 6
4.7	Save Files to USB Storage Device	4 - 7
4.8	Restore Files from USB Storage Device	4 - 8
4.9	USB Link with PC	4 - 9
4.10	Calibration Check	4 - 9
4.11	Setup Balance Interface	4 - 1 0
4.12	Printer Mode	4 - 1 1
4.13	Reset to Default Settings	4 - 1 2
4.14	Update Software	4 - 1 2

4 GENERAL OPTIONS

The **General Options** screen gives access to options that are not directly related to the titration process. To access this screen, press General Option from the main screen while in idle mode. In Pre-titration, Drift Analysis, Standby or Titration process, the General Options can be accessed by pressing the <<Home>> key on a PS/2 keyboard. The available menus are described below:

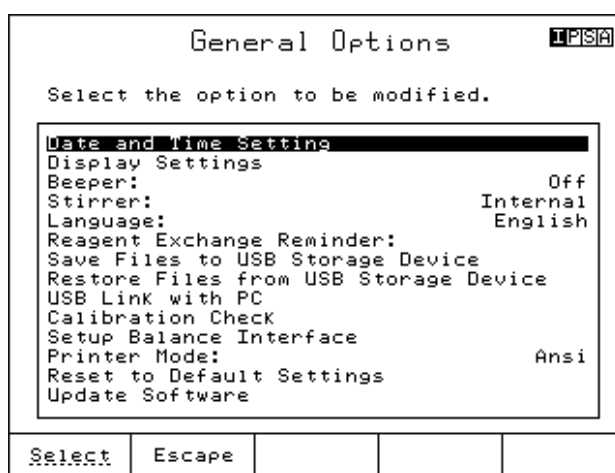

4.1 Date and Time Setting

This screen allows the user to set the date and time.

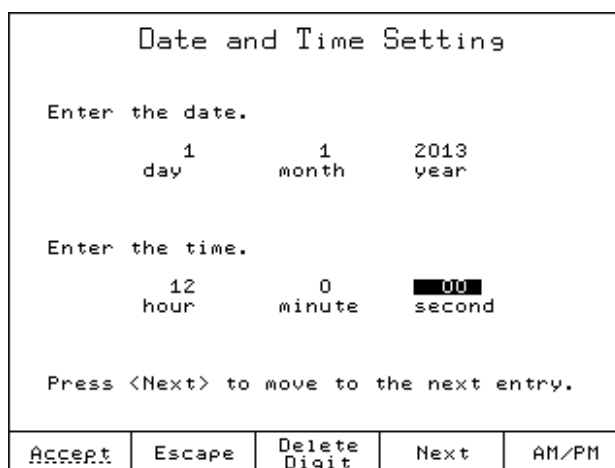

Use the and keys or the numeric keys to modify the date and time.

Press Next to move the cursor to the next field.

Press AM / PM or 24-hour to change the time format.

GENERAL OPTIONS

4.2 Display Settings

This screen allows the user to customize the viewing features of the display.

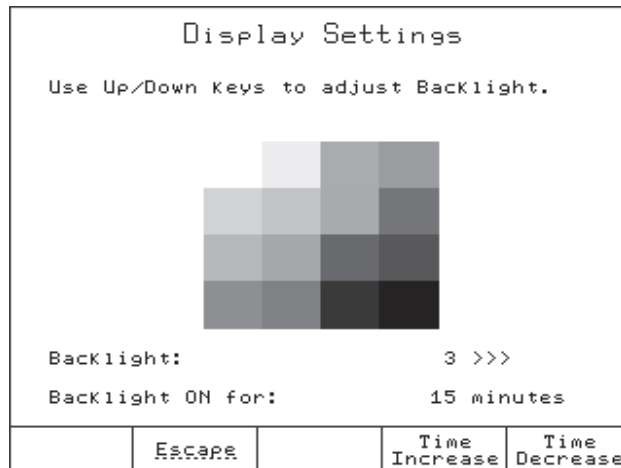

Option Keys:



Increases the backlight saver time interval

Decreases the backlight saver time interval

The backlight intensity can be adjusted using the \triangle and ∇ keys.

There are 8 levels of backlight intensity, ranging from 0 to 7.

A color palette is displayed in the center of the screen, allowing an easy selection of the appropriate backlight intensity.

The backlight saver option protects the display during standby periods, when no keys have been pressed for a set amount of time.

If the backlight is off, any keystroke will re-activate the backlight without performing any action.

The range for backlight saver interval is between 1 and 60 minutes. To disable the backlight saver, increase the time to the maximum allowed; the "Off" indication will appear.

4.3 Beeper

This screen allows the user to turn the Beeper On (*Enable*) or Off (*Disable*).

The screenshot shows a terminal window titled "Beeper". The text "Select the option." is displayed above a list box containing two options: "Beeper Off" (highlighted with a black bar) and "Beeper On". At the bottom of the window is a control bar with five buttons: "Select", "Escape", and three empty buttons.

The beeper will sound after a titration is completed, when an invalid key is pressed or when a critical error occurs during titration.

4.4 Stirrer

This screen allows the user to select the internal magnetic stirrer, an external magnetic stirrer or a user-controlled stirrer uncontrolled by the titrator (custom).

The screenshot shows a terminal window titled "Stirrer". The text "Select the option." is displayed above a list box containing three options: "Internal" (highlighted with a black bar), "External", and "Custom". At the bottom of the window is a control bar with five buttons: "Select", "Escape", and three empty buttons.

The external stirrer is automatically detected when it is connected.

Note: When the external stirrer is not connected the  key is not available for the "External" stirrer option.

GENERAL OPTIONS

4.5 Language

Select an available language.

Set Language				
Select the language.				
English Español Portuguese Français				
Select	Escape			

4.6 Reagent Exchange Reminder

Coulometric Karl Fischer reagents have a limited titration capacity, meaning that there is a limited amount of water that a volume of reagent can react. For this reason, the **HI 904** automatically tracks the total amount of water that has been reacted since the reagent was added to the titration vessel. By default, an "Exchange Reagent" reminder will appear after 1000 mg of water have been titrated.

Coulometric Karl Fischer reagents also have a tendency to produce precipitates and foul-smelling sulfurous compounds. This is particularly problematic when using a diaphragm generator due to the risk of clogging the diaphragm. Most reagent manufacturers recommend changing the reagent (anolyte and catholyte) weekly regardless of the amount of use. The **HI 904** can automatically track the elapsed time since the reagent was added to the titration vessel by setting a reminder timer.

Reagent Exchange Reminder				
Select the option.				
Timer: 7days, 0hours Water Consumption: 1000.0 mg Reset Reminder				
Select	Escape			

Both reminder types (timer and water counter) are automatically reset after using the air pump. The reminders can be manually reset by selecting the "Reset Reminder" option.

4.7 Save Files to USB Storage Device

This option allows the user to save files from titrator to a USB storage device.

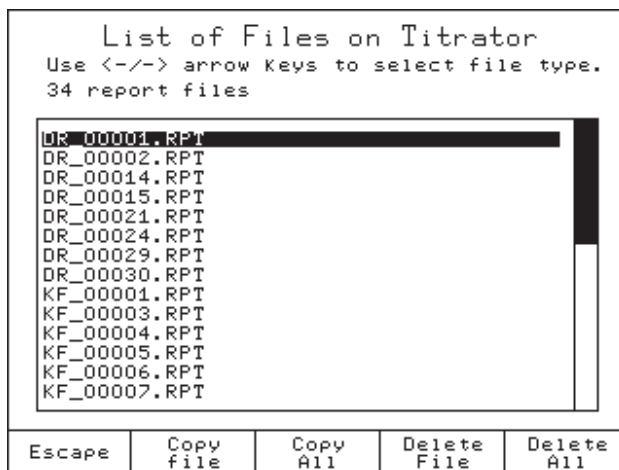

On the titrator, the available file types are:

- Standard Method Files - **HIxxxxyy.MTD** (e.g.: HI9001EN.MTD, HI9101EN.MTD)
- User Method Files - **USERxxxx.MTD** (e.g.: USER0001.MTD)
- Drift/Titration Report Files - **DR_xxxxx.RPT, KF_xxxxx.RPT**
(e.g.: DR_00001.RPT, KF_00001.RPT)

Insert the USB Storage Device into the USB port on the left side of the titrator.

Use the ◀ and ▶ keys to switch between the 3 file types. The number of files and each file name on the titrator will be displayed.

Use the ▲ and ▼ keys to scroll through the list.

The option keys allow the following operations:

- | | |
|-------------|--|
| Escape | Returns to the General Options screen |
| Copy File | Copies the highlighted file from titrator to a USB storage device |
| Copy All | Copies all currently displayed files from titrator to a USB storage device |
| Delete File | Deletes the highlighted file. |
| Delete All | Deletes all currently displayed files. |

The status of the transfer ("successful" / "unsuccessful") and the file name of the currently processed file are displayed during copying or deleting.

Note: The saved files will be stored on the USB Key in the HI 904 folder, as follows:

- Methods: USB Drive: \ HI 904 \ Methods \ *.mtd
- Reports: USB Drive: \ HI 904 \ Reports \ *.rpt

GENERAL OPTIONS

4.8 Restore Files from USB Storage Device

This screen allows the user to transfer files from the USB storage device to the titrator. Insert the USB Storage Device into the USB port on the left side of the titrator.

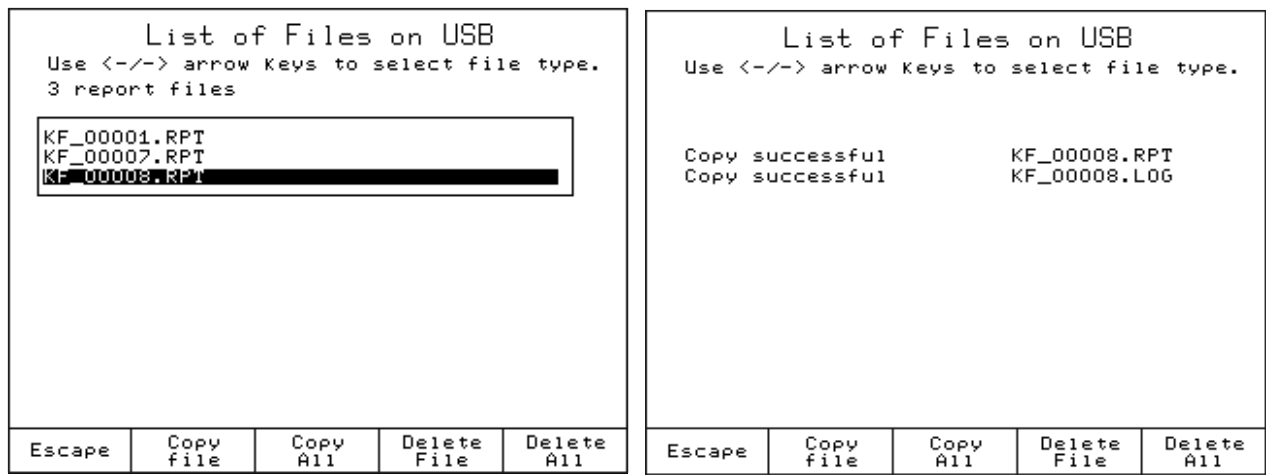

The file types that can be transferred are:

- Standard Method Files - **HIxxxxyy.MTD** (e.g.: HI9001EN.MTD, HI9101EN.MTD)
- User Method Files - **USERxxxx.MTD** (e.g.: USER0001.MTD)
- Drift/Titration Report Files - **DR_xxxxx.RPT, KF_xxxxx.RPT**
(e.g.: DR_00001.RPT, KF_00001.RPT)

Use the ◀ and ▶ keys to select the file type.

Use the ▲ and ▼ keys to scroll through the list.

The number of files and the name of each file found on the USB storage device is displayed on the screen.

The option keys allow the following operations:

- Escape** Returns to the **General Options** screen.
- Copy File** Copies the highlighted file from the USB storage device to titrator.
- Copy All** Copies all currently displayed files from the USB storage device to titrator.
- Delete File** Deletes the highlighted file from the USB storage device.
- Delete All** Deletes all currently displayed files from the USB storage device.

Note: In order to restore files from USB Key, please ensure that the methods and/or reports you wish to transfer to the titrator are in the correct folder:

- Methods: USB: \ Drive \ HI 904 \ Methods \ *.mtd
- Reports: USB: \ Drive \ HI 904 \ Reports \ *.rpt

4.9 USB Link with PC

The USB Link feature is useful to transfer methods/reports directly to/from a PC. To use this feature, connect the USB cable to the labeled connector on rear of titrator and connect to a PC with **HI 900** PC Application installed. The titrator automatically attempts to connect to the PC while on this screen.

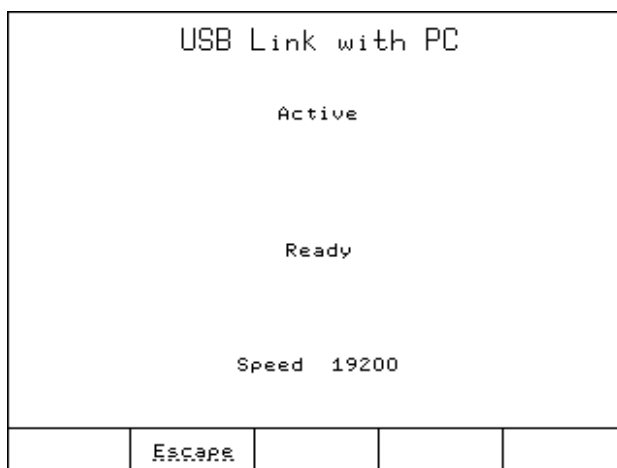

Inactive: The titrator is not connected to the **HI 900** PC Application.

Active: The titrator is connected to the **HI 900** PC Application.

Ready: The titrator is ready for commands.

Transmit: It shows the progress of the current transfer.

Speed: It shows the baud rate for the communications port.

4.10 Calibration Check

This screen allows the user to verify the analog board calibration.

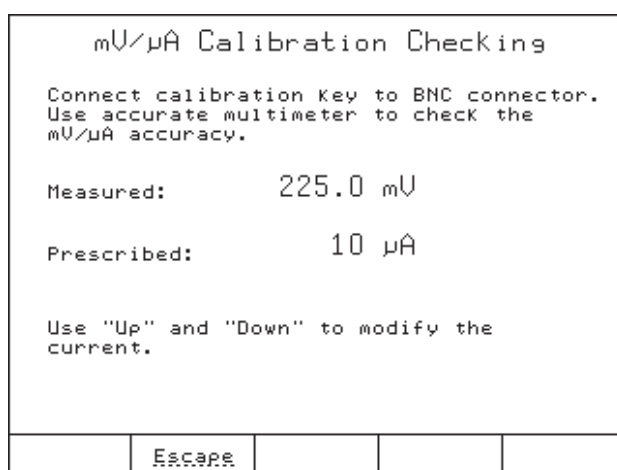

Two parameters can be verified, the *electrode mV input* and the *electrode polarization current*. Both parameters can be measured on the same BNC connector using the calibration key and a mV/µA multimeter (not included).

GENERAL OPTIONS

Disconnect the KF electrode, then connect the **HI 900940** calibration key to the electrode input (BNC connector).

Depending on which parameters you want to check, follow the indications below:

Checking the mV input accuracy:

Set the multimeter to mV mode.

If necessary, switch the calibration key to mV mode by pressing the red button.

Connect the calibration key banana plugs to the multimeter mV input.

Choose the current value using the \triangle and ∇ keys (from the pre-defined list).

Check if the millivolts indication is in accordance with the value displayed on the titrator screen (within 2% accuracy).

Checking the μ A output accuracy:

Set the multimeter to μ A mode.

If necessary, switch the calibration key to μ A mode by pressing the red button.

Connect the calibration key banana plugs to the multimeter mA input.

Check for the multimeter indication to be in accordance with the titrator μ A prescribed value.

4.11 Set Up Balance Interface

This screen allows the user to setup an analytical balance for automatic acquisition of sample mass prior to titration.

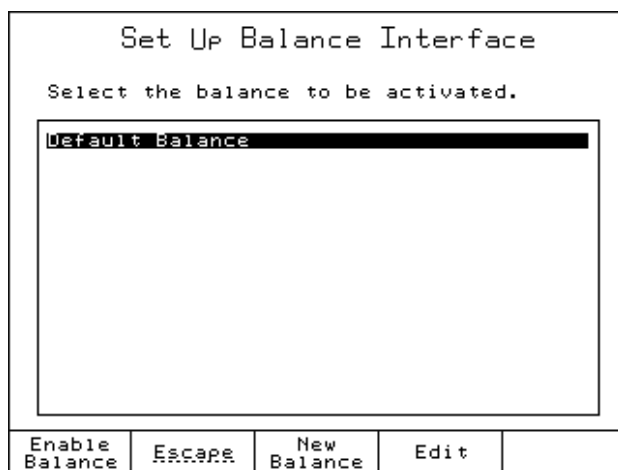

The balance is connected to the titrator via RS 232 interface.

Press  to add a new balance to the list.

Press  to enable the balance interface feature.

Press  to disable the balance feature (automatic mass acquisition will not be available).

Press  to customize the serial communication parameters. The **Balance Configuration** screen will open.

Press  to remove the highlighted balance. Note: At least one balance must be on the list.

Configure the settings on the titrator *Balance Configuration* menu to match the settings for your particular balance (baud rate, data bits, parity, stop bit number, request command syntax). It may be necessary to change settings on your balance. Users should consult their balance instruction manual.

Before leaving this screen, be sure the connection with the balance is working properly by pressing the  key.

Balance Configuration																
Select the option to be modified.																
<table border="1"><tr><td>Balance Name</td><td>Lab Balance</td></tr><tr><td>Baud Rate</td><td>9600</td></tr><tr><td>Data Bits</td><td>8 Bits</td></tr><tr><td>Parity</td><td>No Parity</td></tr><tr><td>Stop Bit</td><td>1 bit</td></tr><tr><td>Edit Request Command</td><td>B</td></tr></table>					Balance Name	Lab Balance	Baud Rate	9600	Data Bits	8 Bits	Parity	No Parity	Stop Bit	1 bit	Edit Request Command	B
Balance Name	Lab Balance															
Baud Rate	9600															
Data Bits	8 Bits															
Parity	No Parity															
Stop Bit	1 bit															
Edit Request Command	B															
Select	Escape		Test Balance													

4.12 Printer mode

This screen allows the user to select the printing mode: ANSI (default), ASCII and Text mode.

Printer Mode							
Select the option.							
<table border="1"><tr><td>Ansi</td></tr><tr><td>Ascii</td></tr><tr><td>Text</td></tr></table>					Ansi	Ascii	Text
Ansi							
Ascii							
Text							
Select	Escape						

ANSI mode:

Use this mode when your printer is set to ANSI. In this case all accepted characters / symbols available on the titrator will be printed by your printer.

ASCII mode:

Use this mode when your printer is set to ASCII. In this case only some of the accented characters / symbols available on the titrator will print.

Text mode:

Use this when you don't need to print the accented characters.

GENERAL OPTIONS

4.13 Reset to Default Settings

This option restores the manufacturer settings.

Note: Please be careful!!! This will also delete all the user created methods, reports and restore all manufacturer settings such as titrator configuration, standard method parameters, etc.

Confirmation of Reset				
Are you sure you want to reset the titrator to manufacturer settings?				
This will delete all user methods and reports.				
Reset	Escape			

4.14 Update Software

This screen allows the user to update the titrator software from a USB storage device containing a software setup kit.

Update Software				
Current version:	HI904 v1.00			
New version:	HI904 v1.01			
Are you sure you want to update the current software with the new version?				
Accept	Escape	Refresh		

Chapter 5. Contents

5	METHODS	5 - 3
5.1	Selecting Methods	5 - 3
5.2	Standard Methods	5 - 4
5.2.1	Upgrading Standard Methods	5 - 4
5.2.2	Deleting Standard Methods	5 - 4
5.2.3	Restoring the Standard Methods to the Manufacturer's Settings	5 - 5
5.3	User Methods	5 - 5
5.3.1	Creating User Methods	5 - 5
5.3.2	Deleting User Methods	5 - 6
5.4	View / Modify Method	5 - 6
5.5	Method Options	5 - 7
5.5.1	Naming the User Method	5 - 7
5.5.2	Method Revision	5 - 8
5.5.3	Method Type	5 - 8
5.5.4	Pre-Analysis Stir Time	5 - 9
5.5.5	Stirring Speed	5 - 9
5.5.6	Stirbar Type	5 - 10
5.5.7	Drift Entry	5 - 10
5.5.8	Reagent Name	5 - 11
5.5.9	Sample Parameters	5 - 12
5.5.9.1	Sample Determination	5 - 12
5.5.9.2	Sample Name	5 - 13
5.5.9.3	Sample Type	5 - 13
5.5.9.4	Sample Size	5 - 14
5.5.9.5	Sample Density	5 - 14
5.5.9.6	External Solvent Size	5 - 15
5.5.9.7	External Solvent Concentration	5 - 15
5.5.9.8	Extracted Sample Size	5 - 15
5.5.9.9	Dissoluted Sample Size	5 - 15

METHODS

5.5.10 Control Parameters	5 - 16
5.5.10.1 Titration Speed	5 - 16
5.5.10.2 Standby Mode	5 - 17
5.5.10.3 Standby Duration	5 - 17
5.5.10.4 Imposed Current	5 - 18
5.5.10.5 End Point Value	5 - 18
5.5.10.6 Generator Current Mode	5 - 19
5.5.10.7 Signal Averaging	5 - 19
5.5.11 Termination Parameters	5 - 20
5.5.11.1 Maximum Duration	5 - 20
5.5.11.2 Maximum Titrated Water	5 - 21
5.5.11.3 Termination Criterion	5 - 21
5.5.11.4 End Point Stability Time	5 - 22
5.5.12 Result Unit	5 - 22
5.6 Printing	5 - 22
5.7 Bromine Index	5 - 23

5 METHODS

All of the parameters required to complete an analysis are grouped into a method. The titrator is supplied with a pack of standard methods. Standard and user methods can be upgraded, stored or deleted by connecting the titrator to a PC using the **HI 900** PC application or a USB storage device.

5.1 Selecting Methods

To select a method, press the  key (when available). A list of available methods will be displayed.

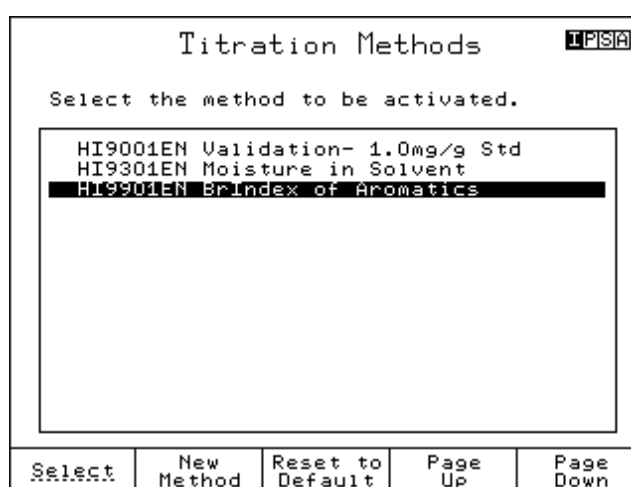

In the **Titration Methods** screen, you can view the list of all available methods (standard and user methods, if available).

To select a method, highlight the method and press . The name of the selected method will be displayed on the screen.

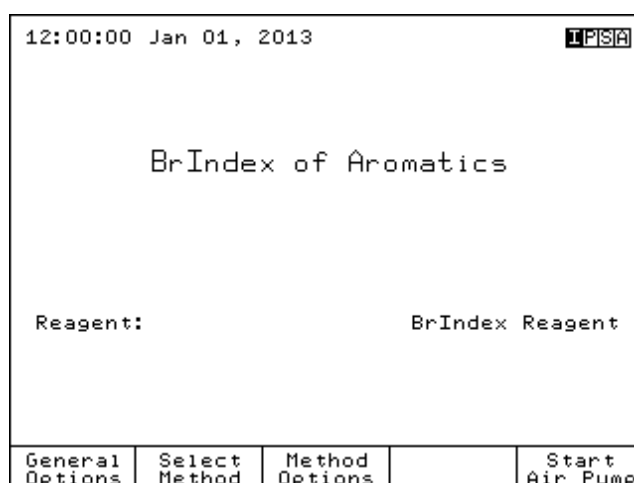

5.2 Standard Methods









The standard methods were developed for the most common types of analysis. Also, the standard methods can be used as a model to create new user methods.

Only specific method parameters can be modified by the user (see Section 5.5, *Method Options* section).

5.2.1 Upgrading Standard Methods

To upgrade the titrator with new standard methods, follow the steps below:

From USB Storage Device:

- Insert the USB storage device into the USB port, located on the left side of the titrator.
- Access the **General Options** screen.
- Using the  and  keys, highlight the *Restore Files from USB Storage Device* option and choose .
- Using the  and  keys, navigate through file types to find "standard method files". The list with available standard methods on the storage device will be displayed.
- Press the  or  key to upgrade the titrator with the standard methods.
- Press  to return to **General Options** screen.

Note: See section 4.8 *Restore Files from USB Storage Device*.









From PC:

You can upgrade the titrator with standard methods from a PC using the **HI 900** PC application (see Section 4.9, *USB Link with PC*).

5.2.2 Deleting Standard Methods

Unnecessary standard methods can be removed from titrator by following the procedure below:

From **General Options** screen:

- Using the  and  keys, highlight the *Save Files to USB Storage Device* option and press .
- Using the  and  keys, navigate through the file types to find "standard method files". The available standard methods will be displayed.
- Press the  or  keys to remove unnecessary standard methods.
- Press  to return to the **General Options** screen.

From PC:

Unnecessary Standard Methods can be removed from the titrator using the **HI 900** PC application (see Section 4.9, *USB Link with PC*).

5.2.3 Restoring the Standard Methods to the Manufacturer Settings

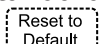
You can restore the standard method to the manufacturer setting by highlighting a standard method and pressing .

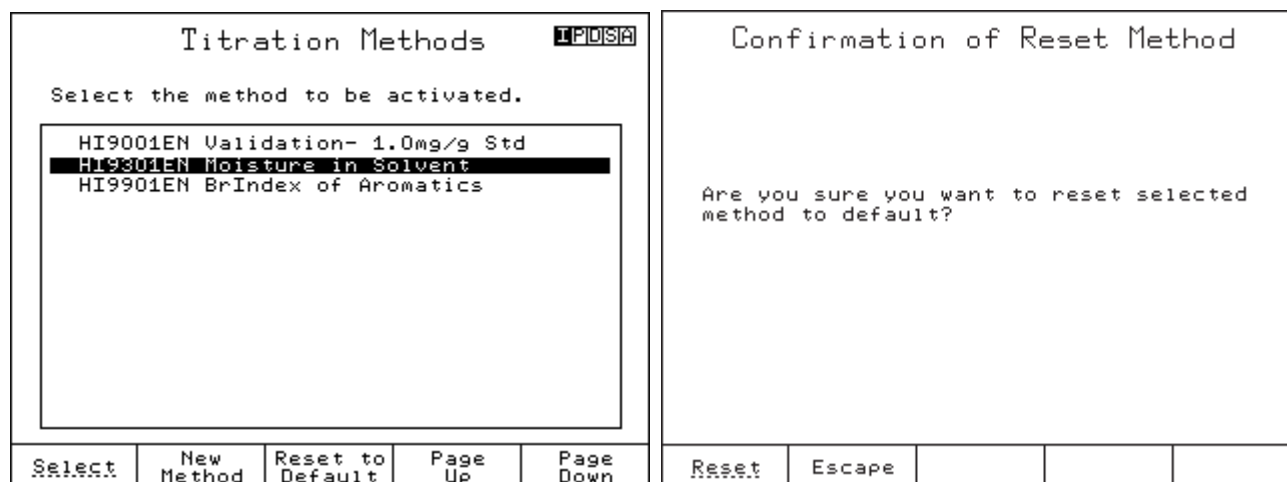





5.3 User Methods

These methods are defined by the user (usually by modifying a standard method). The user methods can be developed in accordance with the requirements of the user. All method parameters can be modified by the user.

5.3.1 Creating User Methods

To create a new user method start from a standard or user method, and follow these steps:

- Press  from the main screen.
- Using the  and  keys, highlight an existing method from the methods list.
- Press . A new user method will be generated.
- Press  to activate the new created user method.

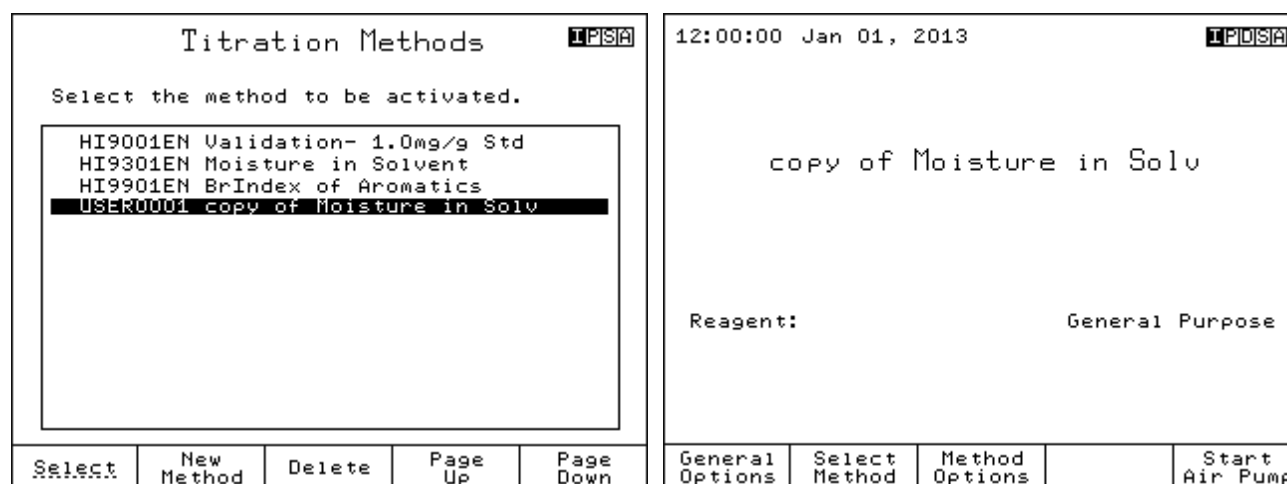

METHODS

Note: Only a limited number of user methods can be generated. The titrator can hold 100 methods (standard and user). When it is reached, a warning message will be displayed.

5.3.2 Deleting User Methods

To remove a user method, press Select Method (when available). Highlight the user method that you want to delete and press Delete. A screen will appear in order to confirm the deletion. Press Delete again to confirm, or press Escape to cancel the operation.

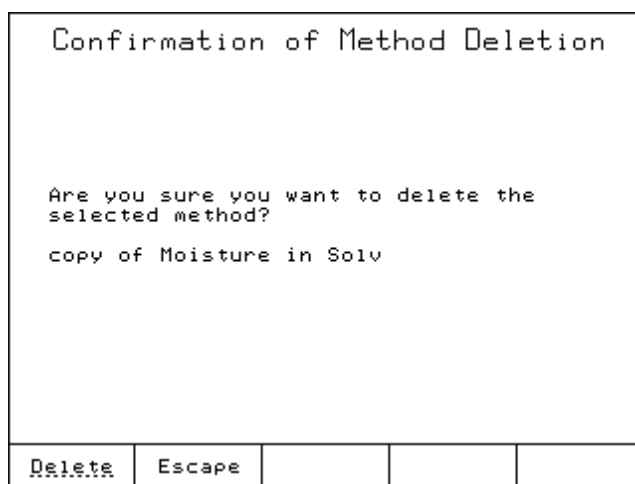

5.4 View / Modify Method

To modify the method's parameters, press Method Options from the main screen. A list of all the parameters for the selected method will be displayed. Press the \triangle and ∇ keys to highlight the option that you want to modify and choose Select.

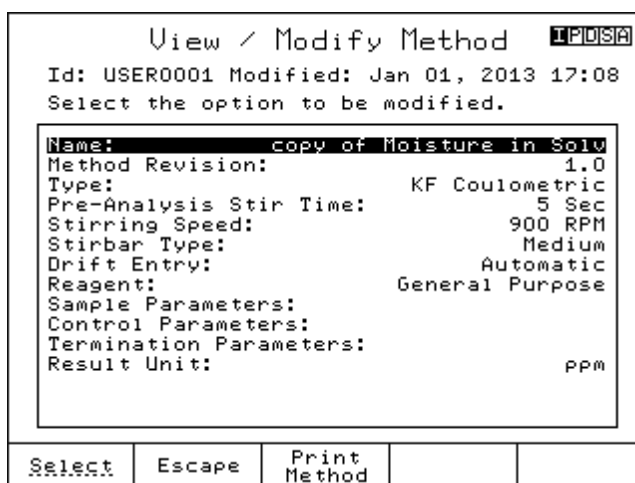

Save method:

After making modifications, press Escape and select **Save Method** to keep the changes.

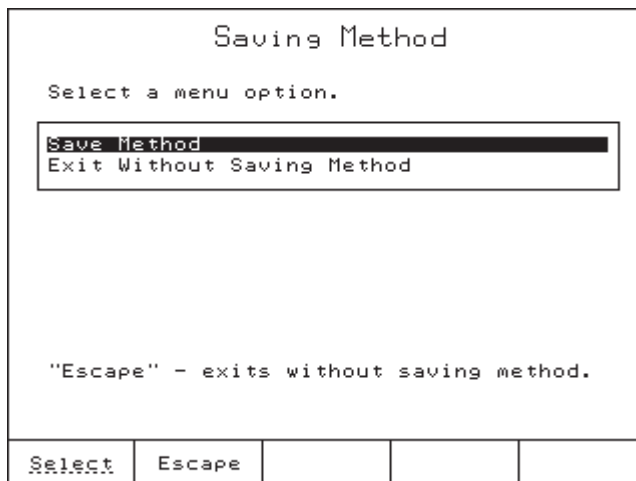

5.5 Method Options

5.5.1 Naming the User Method

This option allows you to enter a name for the new method (up to 24 characters). Use the arrow keys to navigate through the character table. Press enter to add the highlighted character to the method name.

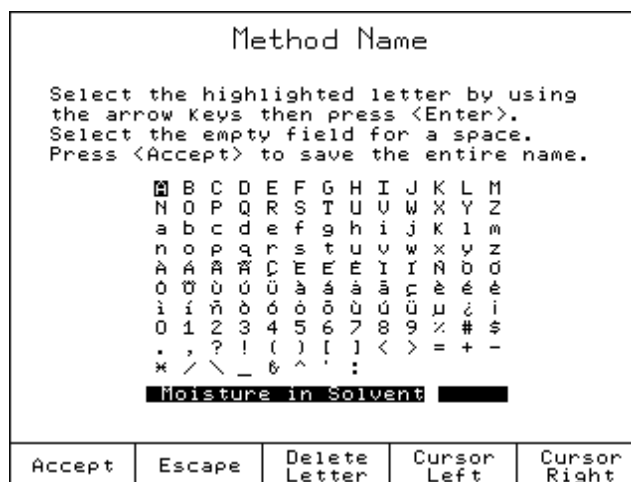

METHODS

5.5.2 Method Revision

This option allows you to enter a string representing the current method revision. The revision string format should be "X.Y", where X and Y are numerical digits.

Method Revision

Select the highlighted letter by using the arrow keys then press "Enter".
Select the empty field for a space.
The revision string format is "X.X".

B	C	D	E	F	G	H	I	J	K	L	M				
N	O	P	Q	R	S	T	U	V	W	X	Y	Z			
a	b	c	d	e	f	g	h	i	j	k	l	m			
n	o	p	q	r	s	t	u	v	w	x	y	z			
À	Á	Â	Ã	Ä	Å	Ç	È	É	Ê	Ë	Ï	Ñ	Ò	Ó	
Ô	Õ	Ö	Ù	Ú	Û	ä	å	ä	å	ç	è	é	ê	ë	
ì	í	ñ	ò	ó	ô	õ	ö	ù	ú	û	ü	µ	¿	¡	
0	1	2	3	4	5	6	7	8	9	%	#	\$	&	@	
.	,	?	!	()	[]	<	>	=	+	-	*	/	
*	/	\	_	`	^	'	:	;	,	.	<	>	=	+	-

■1.0

Accept	Escape	Delete Letter	Cursor Left	Cursor Right
--------	--------	---------------	-------------	--------------

5.5.3 Method Type

Method type is a parameter listed in each method.

In order to conduct a titration the user has to choose between KF Coulometric or Bromine Index.

Method Type

Choose the method application type.

KF Coulometric

Bromine Index

Select	Escape		
--------	--------	--	--

5.5.4 Pre-Analysis Stir Time

To avoid erroneous results or unreachable endpoints when analyzing samples with limited solubility, the sample must be completely dissolved in the solvent prior to the start of a titration.

The pre-analysis stir time can be set between 5 and 1000 seconds. After the sample is added to the reaction vessel the titrator will stir for the set period of time before any iodine is generated / bromine is consumed.

Pre-Analysis Stir Time				
Enter the initial mixing time prior to the start of the titration.				
██████████ 5 seconds				
Low Limit: 5 seconds High Limit: 1000 seconds				
ACCEPT	Escape	Delete Digit		

5.5.5 Stirring Speed

The stirring speed can be set between 200 and 2000 RPM with a resolution of 100 RPM.

Stirring Speed				
Enter the speed of the stirrer during the titration.				
██████████ 500 RPM				
Low Limit: 200 RPM High Limit: 2000 RPM				
ACCEPT	Escape	Delete Digit		

The stirrer will remain on, as long as the method is active. The speed can be adjusted at any time by using the \triangle and ∇ keys when the stirrer is running.

METHODS

5.5.6 Stirbar Type

Allows the user to edit the stirbar description.

Stirbar Type

Select the highlighted letter by using the arrow keys then press "Enter".
Select the empty field for a space.
Press Accept to save the stirrbar type.

B	C	D	E	F	G	H	I	J	K	L	M							
N	O	P	Q	R	S	T	U	V	W	X	Y	Z						
a	b	c	d	e	f	g	h	i	j	k	l	m						
n	o	p	q	r	s	t	u	v	w	x	y	z						
À	Á	Â	Ã	Ä	Å	Ç	È	É	Ê	Ë	Ì	Í	Î	Ï	Ñ	Ò	Ó	
Ô	Õ	Ö	Ù	Ú	Û	Ü	Ý	à	á	â	ã	ä	å	ç	è	é	ê	ë
ì	í	î	ï	ò	ó	ô	õ	ö	ù	ú	û	ü	ý	ÿ	ÿ	ÿ	ÿ	ÿ
0	1	2	3	4	5	6	7	8	9	%	#	\$						
.	,	?	!	()	[]	<	>	=	+	-						
*	/	\	_	&	^	:												

Medium

Accept	Escape	Delete Letter	Cursor Left	Cursor Right
--------	--------	---------------	-------------	--------------

5.5.7 Drift Entry

Allows the user to choose the drift entry mode that is used during the titration process:

Drift Entry

Choose the drift entry mode.

Automatic

User

Select	Escape		
--------	--------	--	--

Automatic - the drift rate will be calculated automatically after the Pre-titration of the solvent.

User - the drift is set to a fixed value (entered by the user). The user enters the estimated drift value. The drift analysis stage will be skipped and the user must enter the drift value between 0.0 µg/min and 10.0 µg/min.

```

User Drift Value

Enter the background drift value for final
result correction.

      8.0 µg/min

Low Limit:  0.0 µg/min
High Limit: 10.0 µg/min
    
```

Accept	Escape	Delete Digit		
--------	--------	--------------	--	--

5.5.8 Reagent

The user can enter a name for the reagent (up to 15 characters). Use the arrow keys to navigate through the character table; press to add the highlighted character to the reagent name.

```

Reagent Name

Select the highlighted letter by using
the arrow keys then press <Enter>.
Select the empty field for a space.
Press <Accept> to save the sample name.
    
```

Accept	Escape	Delete Letter	Cursor Left	Cursor Right
--------	--------	---------------	-------------	--------------

5.5.9 Sample Parameters

This screen allows the user to access and configure the specific sample parameters.

Sample Parameters	
Select the option to be modified.	
Sample Determ.:	Normal
Sample Name:	DefaultSample
Sample Type:	Volume
Sample Size:	0.5000 mL
Sample Density:	1.000 g/mL

Select	Escape			
--------	--------	--	--	--

5.5.9.1 Sample Determination

This screen allows the user to select the sample determination mode.

Sample Determination	
Select the sample determination mode.	
Normal	
External Extraction	
External Dissolution	

Select	Escape			
--------	--------	--	--	--

Normal sample determination is performed through direct titration of liquid samples that are soluble in solvent and have homogeneous distribution in water.

External extraction is a method for the preparation of insoluble samples that require a water extraction. Using the proper solvents, the sample is broken down into a fine suspension from which the water is extracted and released into the solvent.

External dissolution is a method for the preparation of the following types of samples:

- samples with a very high water content.
- samples that do not exhibit a homogeneous water distribution.
- slow-dissolving samples.
- samples that can contaminate the titration vessel, thus reducing the accuracy, precision, number of titrations between solvent changes and raising the cell maintenance requirements.

5.5.9.2 Sample Name

This screen allows the user to enter a name for the sample (up to 14 characters). Use the arrow keys to navigate through the character table. Press to add the highlighted character to the sample name.

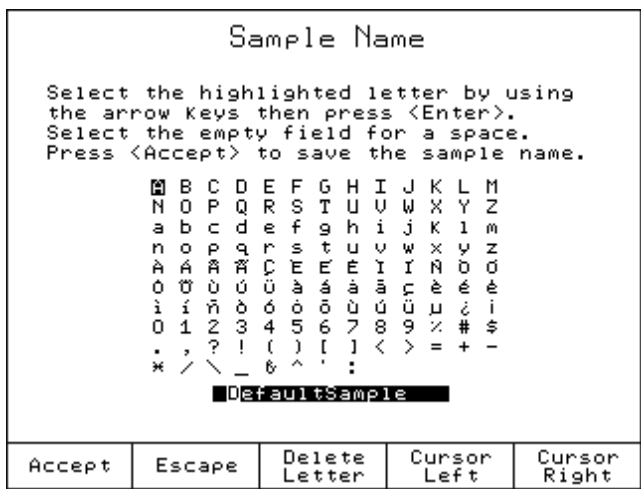

5.5.9.3 Sample Type (Normal Determination only)

This option allows the user to select the type of the sample: mass or volume.

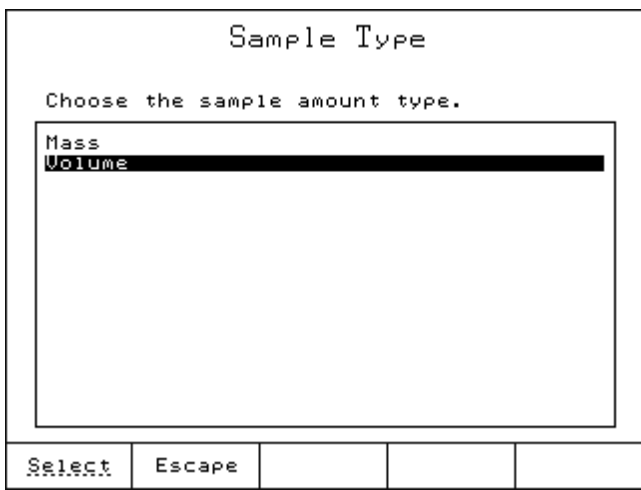

This information is used to determine the appropriate sample size required by the titration prior to analysis.

METHODS

5.5.9.4 Sample Size

Sample Size				
Enter the sample size in current unit.				
0.5000 g				
Low Limit: 0.0010 g				
High Limit: 100.0000 g				
Accept	Escape	Delete Digit		

This option allows the user to enter the sample size. For External/Dissolution, enter the size of the aliquot taken from the external vessel.

Before the titration is started, the user is asked again to enter the sample size. The sample size (mass or volume) can be automatically acquired from the balance (when the balance feature is enabled - see Section 4.11, *Setup Balance Interface*)

5.5.9.5 Sample Density (*Sample Type: Volume only*)

Sample Density				
Enter the value of sample density.				
1.0000 g/mL				
Low Limit: 0.200 g/mL				
High Limit: 3.000 g/mL				
Accept	Escape	Delete Digit		

Enter the density of the sample in g/mL. This allows calculation of mass-based result units with volume-based sample sizes.

5.5.9.6 External Solvent Size (*External Dissolution/Extraction* determination mode only)

Enter the mass of the solvent used for external dissolution or extraction of the sample. Weigh the solvent after determining the solvent water content but before adding sample to the solvent.

```
Sample Parameters
Select the option to be modified.
Sample Determ.: Normal
Sample Name: DefaultSample
Sample Type: Volume
Sample Size: 0.5000 mL
Sample Density: 1.000 g/mL
Select Escape
```

5.5.9.7 External Solvent Conc. (*External Dissolution/Extraction* determination modes only)

Enter the concentration of water in the solvent.

5.5.9.8 Extracted Sample Size (*External Extraction* determination mode only)

Enter the sample size added to the extraction vessel.

5.5.9.9 Dissoluted Sample Size (*External Dissolution* determination mode only)

Enter the sample size to the dissolution vessel.

METHODS

5.5.10 Control Parameters

The user can access and edit the parameters related to the titration.

Control Parameters																		
Select the option to be modified.																		
<table border="1"><tr><td>Titration Speed:</td><td>Auto</td></tr><tr><td>Standby Mode:</td><td>Enabled</td></tr><tr><td>Standby Duration:</td><td>12:00 [hh:mm]</td></tr><tr><td>Imposed Current:</td><td>2 μA</td></tr><tr><td>End Point Value:</td><td>100.0 mV</td></tr><tr><td>Generator Current Mode:</td><td>Auto</td></tr><tr><td>Signal Averaging:</td><td>2 Readings</td></tr></table>					Titration Speed:	Auto	Standby Mode:	Enabled	Standby Duration:	12:00 [hh:mm]	Imposed Current:	2 μ A	End Point Value:	100.0 mV	Generator Current Mode:	Auto	Signal Averaging:	2 Readings
Titration Speed:	Auto																	
Standby Mode:	Enabled																	
Standby Duration:	12:00 [hh:mm]																	
Imposed Current:	2 μ A																	
End Point Value:	100.0 mV																	
Generator Current Mode:	Auto																	
Signal Averaging:	2 Readings																	
Select	Escape																	

5.5.10.1 Titration Speed

Choose the desired titration speed for the method. Some samples or reagents may produce very abrupt endpoints, requiring slower titration speeds in order to avoid over-titration.

Titration Speed								
Select the titration speed.								
<table border="1"><tr><td>Slow</td></tr><tr><td>Normal</td></tr><tr><td>Fast</td></tr><tr><td>Auto</td></tr></table>					Slow	Normal	Fast	Auto
Slow								
Normal								
Fast								
Auto								
Select	Escape							

5.5.10.2 Standby Mode

When enabling this option, the titrator will automatically revert to Standby mode after a titration is completed.

See also the *Standby Duration* option.

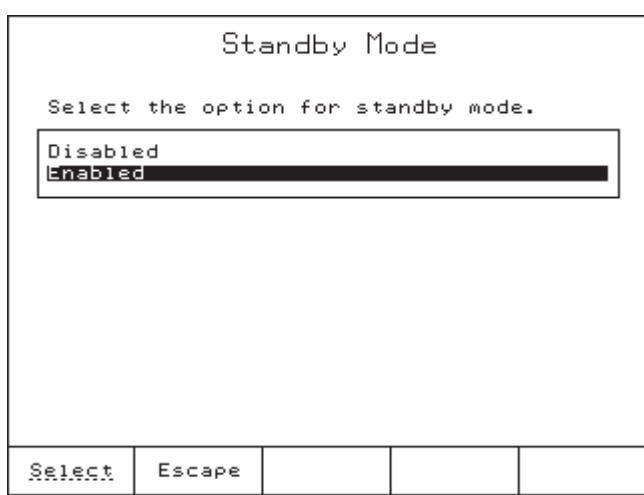

5.5.10.3 Standby Duration

The user can enter the period of time which the cell is kept dry and ready for subsequent analysis after a titration has finished.

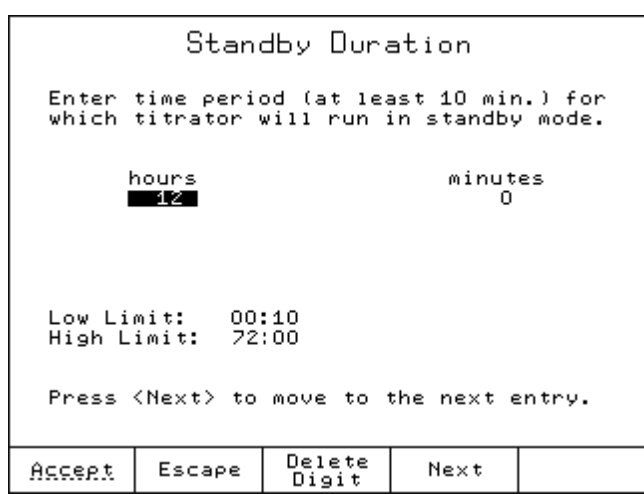

The user can set the standby period up to 72 hours.

METHODS

5.5.10.4 Imposed Current

The **HI 904** uses a bivoltametric indicating electrode system. During a titration, the titrator monitors the voltage required to maintain a constant polarization current (imposed current). This option allows the user to select the electrode polarization current from the predefined list.

Imposed Current				
Choose the imposed current value in μA .				
1 μA				
2 μA				
5 μA				
10 μA				
Select	Escape			

Note: Higher polarization currents will speed the contamination of the electrode and potentially degrade samples.

5.5.10.5 End Point Value

This option defines the mV value at which the titration equivalence point (endpoint) has been reached.

The pre-titration is completed when the mV is under the endpoint value, for a user defined period of time (see Section 5.5.11.4, *Endpoint Stability Time*).

The mV value can be set from 5.0 to 600.0 mV.

End Point Value				
Enter the potential value representing the end point of the titration.				
180.0 mV				
Low Limit: 5.0 mV				
High Limit: 600.0 mV				
ACCEPT	Escape	Delete Digit		

5.5.10.6 Generator Current Mode

This option allows the user to select the generator electrode current mode:

Auto: The titrator will dynamically select the optimal current level (50-400 mA) depending on the dose size and the electrical resistance of the reagent.

Fixed (400 mA): The titrator will always use 400-mA pulses.

Note: If the generator is unable to produce enough current (depending on the Generator Current Mode), an error message will be displayed and the titration will be stopped.

Generator Current Mode				
Select the option to be modified.				
<input type="text" value="Auto"/> Fixed (400mA)				
Select	Escape			

5.5.10.7 Signal Averaging

This option enables averaging of the mV reading when enabled.

If *1 Reading* is selected, the filtering is disabled. The titrator will take the last reading and places it into a "moving window" along with the last 2, 3 or 4 readings (depending on the selected option). The average of those readings is displayed and used for calculations.

Averaging more readings is helpful when a noisy signal is received from the electrode.

Signal Averaging				
Select the number of readings to be averaged.				
1 Reading 2 Readings 3 Readings 4 Readings				
Select	Escape			

METHODS

5.5.11 Termination Parameters

This screen allows the user to set the control parameters related to the end of the titration.

Termination Parameters												
Select the option to be modified.												
<table border="1"><tr><td>Maximum Duration:</td><td>1200 sec</td></tr><tr><td>Maximum water titrated:</td><td>10.000 mg</td></tr><tr><td>Termination Criterion:</td><td>Relative Drift</td></tr><tr><td>Relative Drift:</td><td>3.0 µg/min</td></tr></table>					Maximum Duration:	1200 sec	Maximum water titrated:	10.000 mg	Termination Criterion:	Relative Drift	Relative Drift:	3.0 µg/min
Maximum Duration:	1200 sec											
Maximum water titrated:	10.000 mg											
Termination Criterion:	Relative Drift											
Relative Drift:	3.0 µg/min											
Select	Escape											

5.5.11.1 Maximum Duration

Specify the maximum time a titration is allowed to run. Once this point is reached, the titration will be terminated even if the end point is not reached.

The time can be set from 10 to 3600 seconds.

Maximum Duration				
Enter the time period after the titration is automatically stopped.				
3600 seconds				
Low Limit: 10 seconds High Limit: 3600 seconds				
Accept	Escape	Delete Digit		

5.5.11.2 Maximum Water Titrated

The maximum water reacted during the titration must be set according to the analysis. If the titration end point is not reached, the titration will be terminated after the maximum titrated water has been reacted. The error message ("Limits Exceeded") will appear on the display.

Range is from 0.1 to 100.0 mg.

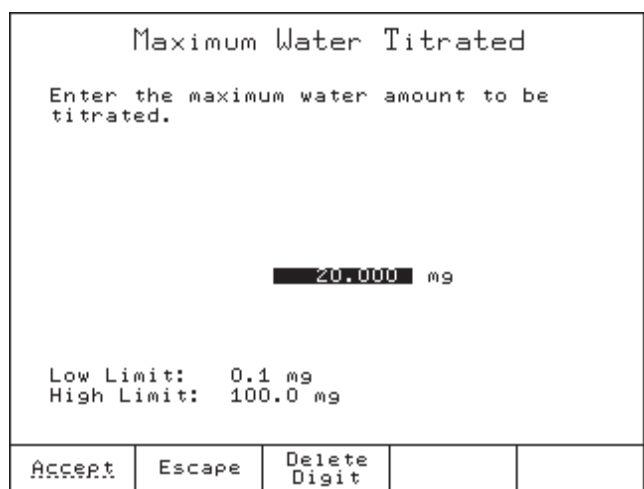

5.5.11.3 Termination Criterion

This screen allows the user to set the titration termination criterion.

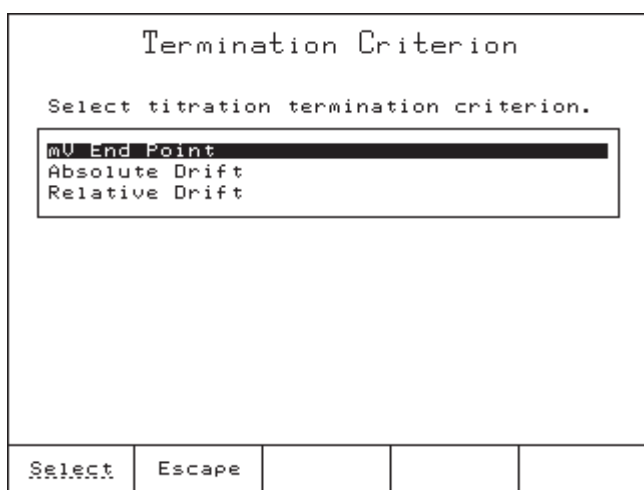

mV End Point The titration is terminated when the potential remains below a set mV value for a specified period of time (see Section 5.5.11.4, *End Point Stability Time*).

Absolute Drift The titration is terminated when the actual drift is less than the predefined absolute drift value.

Relative Drift The titration is terminated when the actual drift is less than the sum between the initial drift and the predefined relative drift.

METHODS

5.5.11.4 End Point Stability Time

This screen allows users to set the time period in which the electrode potential must remain stable.

This setting is in accordance with the *mV End Point* termination criterion.

End Point Stability Time				
Enter the time period necessary to validate the titration end point.				
█ 4 seconds				
Low Limit: 1 seconds				
High Limit: 30 seconds				
ACCEPT	Escape	Delete Digit		

5.5.12 Result Unit

The titrator provides the results based on the selected units.

Result Unit				
Select the unit for your results.				
% mg/g ppt µg/g ppm mg µg				
Select	Escape			

5.6 Printing

To print method parameters, press Method Options from the main screen, then Print Method.

If no printer is connected to the dedicated socket, or if the printer is offline, an error message will appear on the display (see Section 8.5.3, *Connecting a Printer* for information about connecting a printer to the titrator).

5.7 Bromine Index

The **HI 904** is capable of performing Bromine Index/Bromine Number determinations. Bromine Index/Number is a measure of the unsaturation of hydrocarbons, expressed as the amount of bromine required to react with 100 g of sample. Bromine Index is expressed as mg Br/100g; Bromine Number is expressed as g Br/100g. The **HI 904** can be set up to perform Bromine Index determinations by following the steps:

- (1) Prepare the titrator according to Section 2 of the manual, except remove all desiccant from the desiccant cartridges. Bromine Index reagents contains water and will rapidly saturate desiccant.
- (2) Fill a GL45 bottle with Bromine Index reagent. Consult a standard method for preparation instructions.
- (3) Connect the Bromine Index reagent bottle to the titrator and fill the vessel according to Section 2 of the manual.
- (4) Set a method to "Bromine Index" mode by either selecting a bromine index standard method (e.g.: **HI 9901EN**), or by creating a custom method:
 - Go to the **Select Method** screen. Create a new user method for Bromine Index determinations. Select this new method.
 - Go to *Method Options* section, then *Type*:
 - Select *Bromine Index*.
 - Exit *Method Options*. Remember to save the changes to the method.
- (5) Press  .

There are several changes to the user interface while running a Bromine Index method:

- "Drift Analysis" mode has been removed.
- "Relative Drift" and "Absolute Drift" termination criteria have been removed.
- All calculations are as μg (or mg) Bromine.
- Result units have been changed to appropriate Bromine Index units.

Chapter 6. Contents

6	TITRATION	6 - 3
6.1	Idle	6 - 3
6.2	Pre-titration.....	6 - 3
6.3	Drift Analysis	6 - 4
6.4	Standby	6 - 5
6.5	Sample Analysis	6 - 6

6 TITRATION

6.1 Idle

The titrator first enters Idle mode when it is switched on. All of the **HI 904**'s software features and adjustable parameters can be accessed from the Idle state. This includes all of the user-adjustable method parameters, solvent handling system, file transfers, calibration checks, software upgrades, options for interface with PC and accessories as well as burette options.

To access the titration menu (*Process* screen) press .

The titration is performed with the selected method.

Be sure that the selected method is customized in accordance with the specifics of the application.

Before performing a titration, make sure that the following conditions are met:

- All of the attached systems (e.g.: reagent system) are properly assembled.
- The right amount of reagent is present in the titration vessel (between the min and max marks) for best reproducibility.

The following intermediary stages are performed automatically before starting the analysis:

- **Reagent pre-titration**
- **Drift analysis** (*Automatic Drift Entry / KF Coulometric only*)

When the drift analysis process is finished, the titrator enters **Standby** mode. At this point, a titration can be initiated.

6.2 Pre-titration

In pre-titration, the residual water on the interior surface of the titration vessel, the water contained in the entrapped air and the small amount of water from the reagent, is eliminated. The **HI 904** reacts residual water with iodine that is generated electrolytically inside the titration vessel until the specified end point potential is reached; this setting is associated with the active method. After the electrode potential has stabilized, the titrator moves into the Drift Rate Determination Stage.

When the pre-titration is started, the stirrer is automatically turned on (when *Internal* or *External* stirrer is selected).

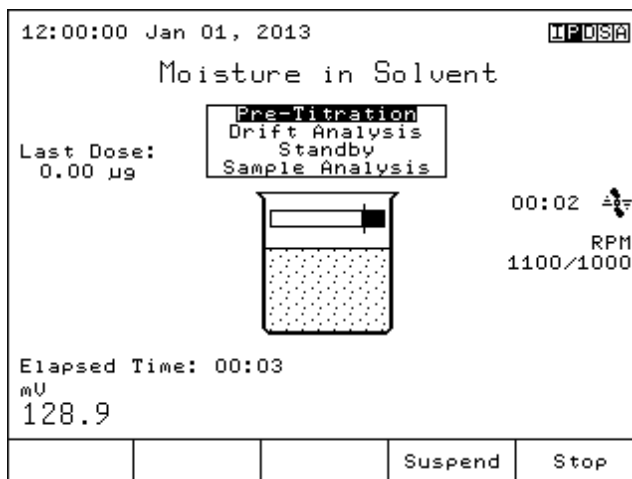

TITRATION

During the pre-titration, the user cannot change the currently selected method or access the method parameters.

Note: If the pre-titration lasts longer than 30 minutes the titrator switches to **Idle** mode. Errors may have occurred in your titration system (beaker is not properly sealed, wrong reagent, unconnected or bad electrode, etc.). Check the system and start pre-titration again.

6.3 Drift Analysis (Automatic Drift Entry / KF Coulometric only)

While in this mode, the **HI 904** conducts an automatic one-minute analysis which determines the amount of moisture leaking into the cell from the atmosphere. Despite the titration vessel being tightly sealed, water will still seep into the cell. The amount of water that migrates into the cell per unit time is known as the background drift rate, or the drift rate.

The drift rate is determined by keeping track of the amount of water that has been titrated to maintain the 'dryness' of the reagent over the course of a minute. The rate at which water leaks into the cell is then calculated and reported by the **HI 904** in units of $\mu\text{g}/\text{min}$.

The **HI 904** uses the drift rate determined during this state to automatically subtract the quantity of water which leaks into the cell during a titration from titration results. This is especially important for titration accuracy when analyzing samples with very low water content where the amount of water which has leaked into the cell is a considerable fraction of the total water titrated during the analysis.

When the drift becomes stable the titrator switches to **Standby** mode.

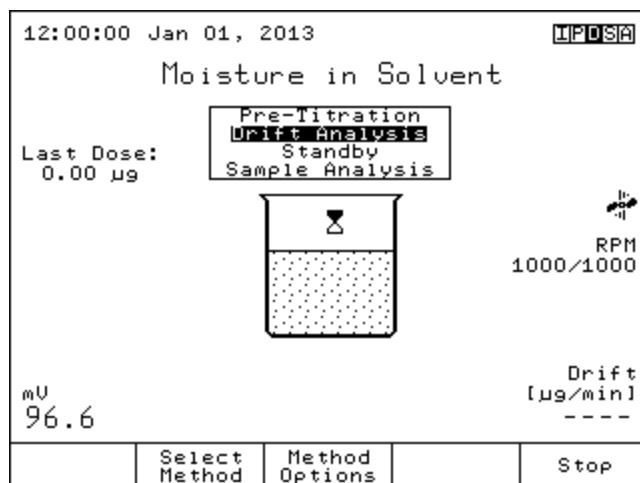

During the drift analysis, if the titrator cannot maintain cell dryness, the titrator reverts to pre-titration.

Note: If the drift entry mode is set as Manual, the drift analysis stage is skipped.

6.4 Standby

After the drift rate has been determined, the **HI 904** moves into **Standby** mode. In standby mode, the dryness of the titration vessel is maintained and the drift rate is continuously monitored and updated.

From **Standby** mode, a sample analysis, or drift rate logging session can be launched as well as method selection, customization of method parameters, and general options (external keyboard only, by pressing <<Home>>).

After an initial titrator setup and prior to the first titration or standardization, the drift rate should be allowed to settle in **Standby** mode for 45 min. This ensures that the drift rate is stable and reflects the actual rate at which water vapor is entering the cell rather than representing a slow drying of the air between the solvent and the top of the cell. The stabilization can be verified by examining the drift rate vs. time curve which can only be accessed from **Standby** mode.

During **Standby**, if the drift becomes unstable, the titrator switches back to **Drift Analysis** mode.

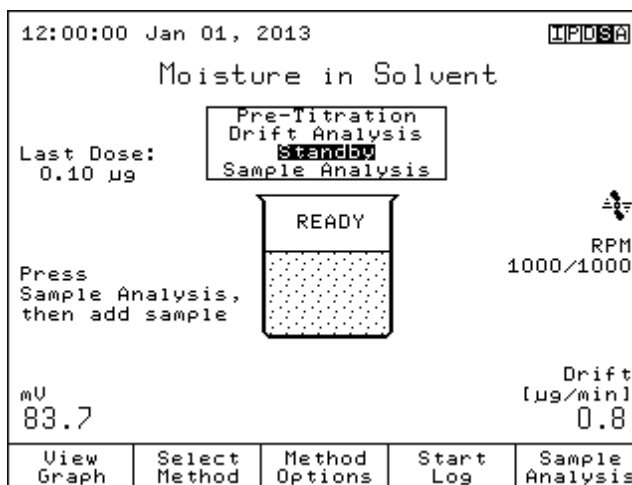

TITRATION

6.5 Sample Analysis

While in **Standby** mode, press Sample Analysis.

Note: If the drift value is zero a warning message appears to inform the user that the solvent may be overtitrated.

WARNING				
Cell May Be Over Titrated!				
Results will be erroneous if the cell is over-titrated. Press <Continue> to ignore warning and begin titration, or press <Escape> to wait for a positive drift rate.				
Continue	Escape			

The user can choose to continue the titration by pressing Continue or to return to **Standby** mode by pressing Escape in order to wait until the drift is stabilized at a higher value.

Add Sample				
Please add the sample and enter the sample size.				
Estimated Conc.	1.0000	×		
Sample Size	0.2691	g		
Optimal Limits				
Low Limit:	0.2 g			
High Limit:	0.3 g			
Press <Start Analysis> to start the sample analysis.				
Start Analysis	Escape	Delete Digit	Next	

Entering estimated concentration: The user has the option to enter the estimated concentration. The optimal sample size limits will be automatically updated based on the estimated concentration.

Adding the sample: The user must add the sample into the titration vessel via the sample port.

Entering sample size: The user has two options to determine the sample size.

Manual Entry

Follow the steps below:

1. Attach a long needle (approximately 6 in. for best control) to a syringe that is large enough to hold at least one complete sample volume. For the volumetric addition of samples, use a precision-volume syringe.
2. Rinse the syringe and needle with sample 2-3 times by drawing in a small portion of sample, fully extending the plunger, shaking to coat the syringe interior, and expelling the sample into a waste collection container.
3. For samples with low water content (less than 200 ppm), the final syringe rinse should not include drawing in air – humidity in the air could significantly contaminate the sample.
4. Draw enough sample into the syringe for at least one titration.
5. Dry the outside of the needle with a lint-free wipe or tissue.
6. For samples by mass, place the full syringe with needle on an analytical balance. Tare the balance (back-weighing technique).
7. Insert the needle through the septum in the sample port. Push the syringe through the septum until the end of the needle is approximately 1 cm from the surface of the reagent.
8. Steadily dispense the appropriate amount of sample, ensuring that the sample is introduced directly into the reagent and does not splash or spatter onto the wall of the titration vessel or electrodes.
9. For samples by mass, draw a small amount of air from inside the titration vessel into the syringe to ensure that no sample drops remain on the tip of the needle.
10. If a drop is observed on the needle, briefly dip the needle into the reagent to remove it.
11. Remove the syringe and needle from the septum taking care to not touch the needle to the other internal vessel components.
12. Enter the dispensed amount of sample. For samples by mass, re-weigh the syringe to determine the mass of dispensed sample (back-weighing technique).

TITRATION

Automatic Mass Acquisition from Analytical Balance

The sample size can be automatically acquired from the balance when connected to the titrator using the RS232 interface.

Note: The user must make sure that the balance and the titrator are properly configured and the balance feature is enabled (see Section 4.11, Setup Balance Interface).

Sample Weighing				
Balance: Lab Balance				
Initial Weight: 0.2814 g				
Final Weight: -----				
Put weighing boat on the balance.				
Press <Accept> to update weight.				
Accept	Escape		Balance Setup	

Procedure

1. Place the syringe containing the sample on the balance.
2. Wait until the reading is stabilized and press .
3. Add the sample in the titration vessel.
4. Place the empty syringe on the balance again.

Sample Weighing				
Balance: Lab Balance				
Initial Weight: 0.2814 g				
Final Weight: 0.0117 g				
Put empty weighing boat on the balance.				
Press <Accept> to update weight.				
Accept	Escape		Balance Setup	

5. Wait for the reading to stabilize and press .

The titrator returns to the previous screen and the sample size is automatically updated.

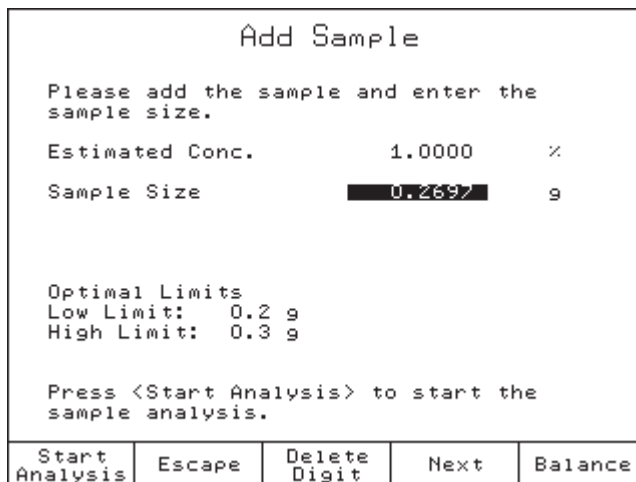

Now the analysis can be started.

Start Analysis

Press **Start Analysis** to begin analysis.

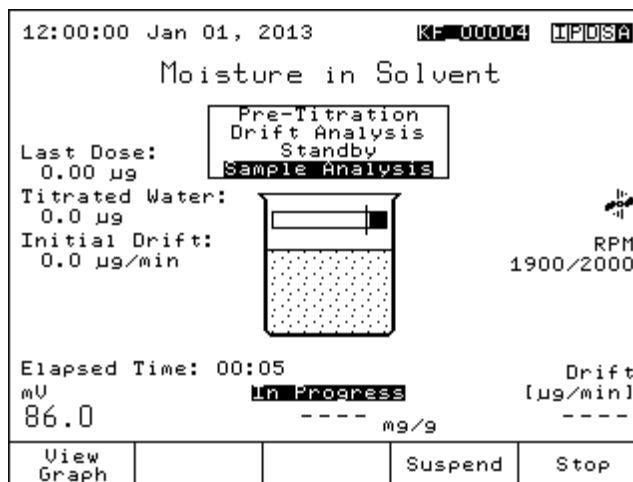

Suspend Titration

While the titration is in progress, you can temporarily stop it by pressing **Suspend**. The generator will stop producing iodine.

To continue the titration press **Resume**.

TITRATION

Viewing the Titration Curve

During a titration, the titration curve can be displayed on the **Titration Graph** screen, by pressing . The titration report ID is also displayed inside the graph window.

Press  to stop the titration manually and return to **Idle** mode.

Press  to stop the titration and return to **Standby** mode.

When the end point is reached the titration is finished and the following screen is displayed.

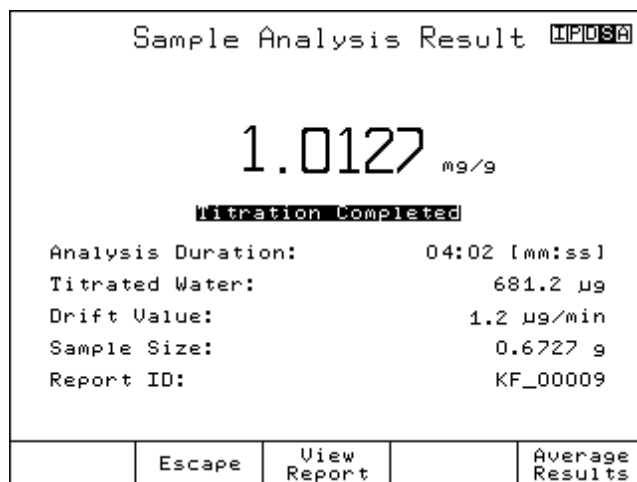

This screen displays information about the titration (duration, drift value used for compensation, sample size, titration report ID).

Press  to see the titration report.

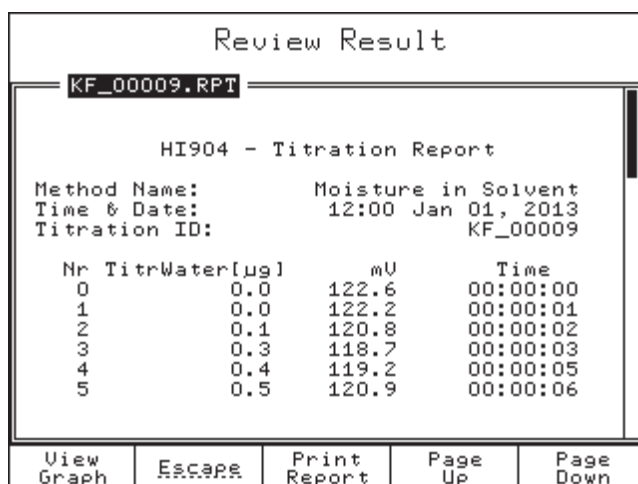



Press  to see the titration graph.

Press  to print the report.

Averaging Sample Analysis Results

By pressing , the *Sample Analysis History*, *Averaging* and *Statistical Data* can be viewed.

Use the  and  keys to scroll the results list.

Use  to choose the results that will be used for averaging.

Sample Analysis History				
Date/Time	Sample Conc.(mg/g)			
Jan 01, 2013 12:00	1.0711			
Jan 01, 2013 12:00	1.0628			
Titrated Water:	560.2 µg			
Sample Size:	0.5247 g			
Average Sample Conc.:	1.0694 mg/g			
Standard Deviation:	0.0025 mg/g			
Select	Escape			Delete

Note: When there are no results selected, dashes will appear in the Average Sample Concentration and the Standard Deviation fields.

Chapter 7. Contents

7. AUXILIARY FUNCTIONS	7 - 3
7.1 Air Pump	7 - 3
7.1.1 Filling the Vessel	7 - 3
7.1.2 Emptying the Vessel	7 - 3
7.2 Stirrer	7 - 4
7.3 Results	7 - 4
7.3.1 Review Last Titration Report	7 - 5
7.3.2 Review Available Reports	7 - 5
7.3.3 GLP Data	7 - 6
7.3.4 Meter Information	7 - 7
7.3.5 Setup Titration Report	7 - 8

7 AUXILIARY FUNCTIONS**7.1 Air Pump**



The air pump is used to add or remove the reagent in the titration vessel without exposure to atmospheric moisture.

To start the air pump, press  from the *Idle* screen.

The air pump can be stopped by pressing .

7.1.1 Filling the Vessel

To add reagent to the titration vessel:

1. Set up the reagent and waste bottle assemblies (*see Section 2.3.5 Reagent, Waste Bottle Assembly*).
2. Attach the Reagent Exchange Adapter to the dedicated port on the titration vessel. Ensure that the reagent and waste tubes are properly attached to the Reagent Exchange Adapter by tightening the compression caps.
3. Depress the  button on the top of the pump housing. Pressing the rubberized button creates a seal which provides the pressure required for the reagent to flow into the cell. Hold the button down until the level of reagent inside the cell reaches the 'min' indicator line. If the reagent is not flowing, or is flowing very slowly, verify that the bottle top assemblies are properly assembled, tightly sealed and that the liquid handling tubing reaches the bottom of the reagent bottle.
4. When the level of reagent inside the titration cell reaches the 'min' line release the  button and deactivate the air pump with the  option key.
5. Return the Reagent Exchange Adapter to its holder. Return the glass stopper to the titration vessel port.

7.1.2 Emptying the Vessel

To remove the waste from the titration vessel:

1. Set up the reagent and waste bottle assemblies (*see Section 2.3.5 Reagent, Waste Bottle Assembly*).
2. Attach the Reagent Exchange Adapter to the dedicated port on the titration vessel. Ensure that the reagent and waste tubes are properly attached to the Reagent Exchange Adapter by tightening the compression caps.
3. Loosen the waste tube compression cap slightly and slide the waste tube down until it reaches the bottom of the vessel.
4. Press and hold the  button until all of the waste is removed from the vessel.
5. Return the waste tube back into its original position and re-tighten the cap.
6. Return the Reagent Exchange Adapter to its holder. Return the glass stopper to the titration vessel port.

AUXILIARY FUNCTIONS

7.2 Stirrer

Note: When custom stirrer is selected (see Section 4.4, *Stirrer in General Options chapter*), the commands related to the stirrer are not available.

The stirrer can be turned on and off by pressing  while in *Idle* mode.

During the titration process the stirrer cannot be turned off.

The stirring speed is set within the method parameters (see Section, 5.5.5 *Stirring Speed*).

During the titration process, the stirring speed can be manually adjusted by using the  and

 keys.

7.3 Results

To access the "Data Parameters" screen, press **results** button.

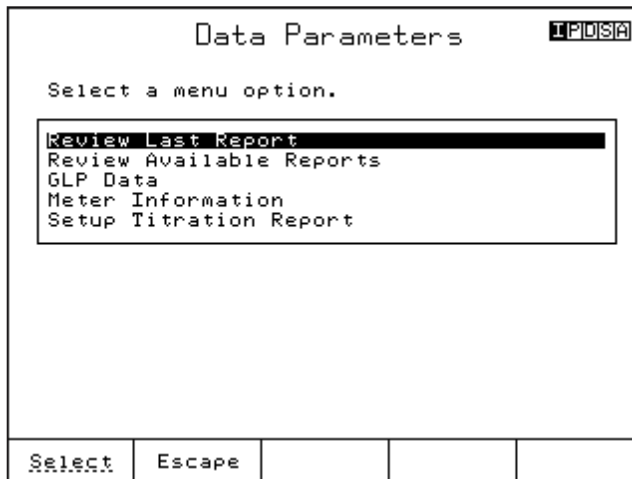

From the **Data Parameters** screen you can access the following options:

7.3.1 Review Last Titration Report

The last titration report can be reviewed.

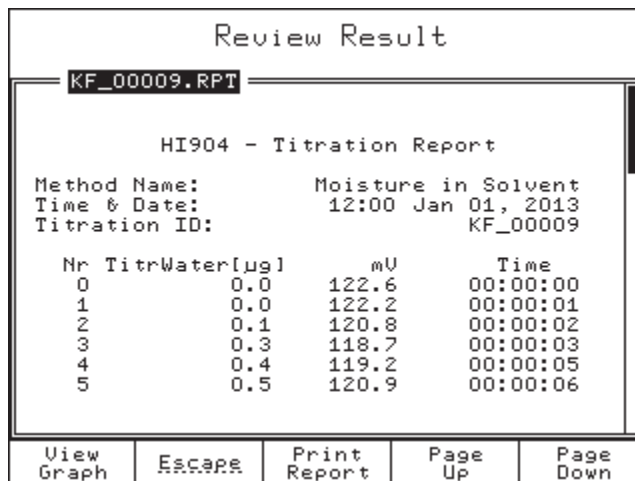

The information seen in the report is based on the selections made in the **Setup Titration Report** screen.

The following option keys are available:

The titration graph can be reviewed by selecting **View Graph**.

Print Report Print the titration report.

AUXILIARY FUNCTIONS

7.3.2 Review Available Reports

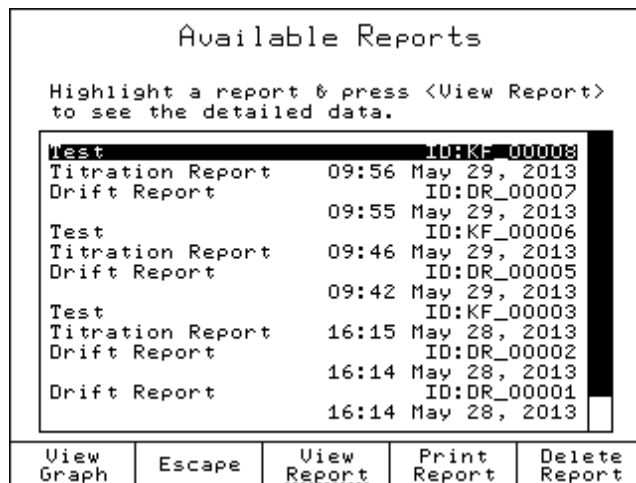

Up to 100 reports can be saved on the titrator. To view one of the saved reports highlight a report and then press .

All of the saved reports can be reviewed and printed.



The report contains only the information selected in the **Setup Titration Report** screens during report generation.

The following option keys are available:

-  Review the titration graph.
-  Print the titration report.
-  Delete the selected report.

7.3.3 GLP Data

GLP data can be optionally be displayed in each report.

Enter up to 20 alphanumeric characters for each option from **GLP Data** screen.

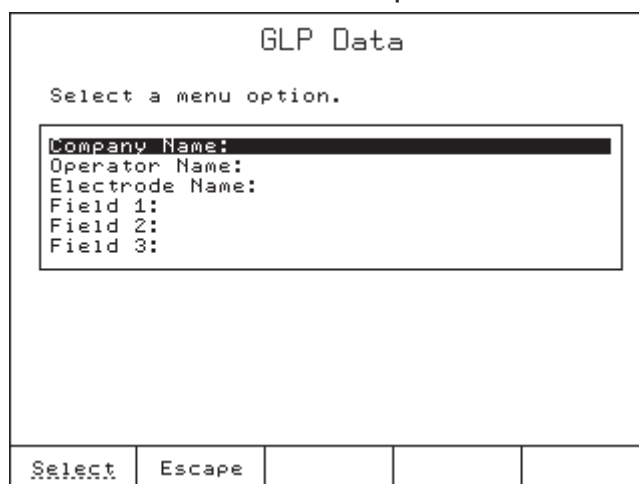

Company Name: Allows the company name to be recorded in each report.

Operator Name: Allows the operator name to be recorded in each report.

Electrode Name: Allows the electrode name to be recorded in each report.

Fields 1, 2, 3: Allows any additional information to be recorded in each report.

The fields must be selected from the **Setup Titration Report** screen (see Section 7.4.5, *Setup Titration Report*) in order to be displayed in the titration report.

7.3.4 Meter Information

Displays titrator configuration data.

Meter Information			
HI 904 Karl Fischer Coulometric Titrator			
SERIAL NUMBER			
Titrator Serial Number:		04132503	
Analog Board Serial Number:		33132503	
SOFTWARE VERSION			
Titrator Software Version:		v1.00	
Base Board Software Version:		v3.00	
Analog Calibration Date:		Feb 25, 2013	
Generator Electrode Type:		HI 900511	
ESCAPE	Print		

Titrator Serial Number: The serial number of the titrator base board.

Analog Board Serial Number: The serial number of the titrator analog board.

Titrator Software Version: The current software version installed on the titrator.

Base Board Software Version: The current software version present on the base board of the titrator.

Analog Calibration Date: Manufacturer calibration date of analog board.

Note: *If more than 1 year elapsed from the calibration date of the analog board, the message **Analog Calibration Due** will appear on the main screen and analog board recalibration must be performed.*

Generator Electrode Type: The HI code of the currently-connected generator electrode.

AUXILIARY FUNCTIONS

7.3.5 Setup Titration Report

Customize a unique report to record the titration results. An asterisk means that it will be included in the titration report.

Setup Titration Report				
Select fields to be saved in the report.				
<ul style="list-style-type: none">* Result and Units* Titration Method* Sample Size* Titrated Water* Titration Duration* Date and Time* Titration Ended By* All Data PointsMethod ParametersCompany NameOperator NameElectrode NameField 1Field 2				
Unselect.	Escape	Save Report	Page Up	Page Down

Chapter 8. Contents

8	MAINTENANCE, PERIPHERALS	8 - 3
8.1	Generator Electrode Maintenance	8 - 3
8.2	Detector Electrode Maintenance	8 - 3
8.3	Reagent Adapter Holder Maintenance.....	8 - 4
8.4	Reagent Exchange Adapter Maintenance.....	8 - 4
8.5	Peripherals.....	8 - 5
8.5.1	Connecting an External Display	8 - 5
8.5.2	Connecting an External PC Keyboard	8 - 6
8.5.3	Connecting a Printer	8 - 8
8.5.4	Connecting to a Computer	8 - 9

8 MAINTENANCE, PERIPHERALS

8.1 Generator Electrode Maintenance

Caution: Never heat generator electrodes over 50°C when drying! This could cause permanent damage to the connector!

Generator electrodes should be cleaned every 1-2 weeks, more frequently if working with "dirty" or "oily" samples.

1. Remove the desiccant cartridge from the top of the generator and disconnect the cable. For generators with diaphragm, use the waste tube to remove the catholyte from the inner compartment.
2. Remove the generator from the titration vessel.
3. Rinse the inner and outer surfaces with dry methanol. Do NOT let any liquid/solvent get near the connector of the electrode!
4. For generators with diaphragm, place the generator in an empty titration vessel and fill the inner compartment with approximately 15-20 mL of dry methanol. Allow the methanol to (slowly) diffuse through the diaphragm to clear it of possible contaminants. For a more thorough cleaning, allow 1 or 2 more aliquots of dry methanol to diffuse through the diaphragm.
5. Wipe joint grease off of the ground-glass joints with a clean, dry cloth or tissue.
6. Allow the generator to dry. Place in a drying oven (max 50°C) for 1 hour, or until no liquid/condensation is visible. If no oven is available, it is better to use the generator immediately in order to avoid adsorption of moisture on residual methanol - especially when using generators with a diaphragm.
7. If visible contamination remains, use an appropriate solvent that will dissolve the contaminant. Soap and water may be used if needed, then rinse and dry.

8.2 Detector Electrode Maintenance

Proper detector maintenance is crucial for reliable measurements and extending the life of the detector. The frequency of maintenance will depend largely on the type of samples that are analyzed. Maintenance may be required if any of the following are observed:

- Slow or no electrode response
- Noisy mV readings
- Debris on or between electrode pins
- Coating on electrode pins

MAINTENANCE, PERIPHERALS

If these signs are observed, the electrode pins may be dirty. Rinse the electrode with a solvent that is appropriate for the type of sample used – methanol is usually sufficient. Remove debris by gently wiping with a clean cloth or tissue. Allow the probe to dry completely before re-installing.

If a more thorough cleaning is required, soak the electrode in **HI 7061** Electrode Cleaning Solution for General Use, for several hours then rinse with water followed by methanol. Allow to dry before re-installing.

After allowing the probe to dry, inspect the glass for cracks, especially near the electrode pins. Replace the electrode if any cracks are found.

Note: *Cleaning the detector electrode with cleaning agents will remove platinum-iodine complexes that have formed on the electrode surface. This will lower the resistance of the detector and therefore lower the detector's mV readings. To counteract this change, lower the endpoint mV value, or raise the imposed current under Method Options. The platinum-iodine complex will reform after several titrations.*

Warning: *Take care to protect the electrode pins from damage! Avoid using brushes/abrasives to clean the pins. Pins can easily bend, which will cause permanent errors in mV readings!*

8.3 Reagent Adapter Holder Maintenance

The glass tube of the reagent adapter holder can be removed for cleaning if reagent and/or waste has dripped into it. To clean the glass tube:

1. Remove the Reagent Exchange Adapter from the top of the holder.
2. Slowly remove the glass tube. Use caution as hazardous reagent/waste may have accumulated inside the tube.
3. Rinse the tube with dry methanol. If needed, use soap and water, then rinse with methanol.
4. Wipe joint grease off of the ground-glass joints with a clean, dry cloth or tissue.
5. Dry the tube in a drying oven, or thoroughly wipe dry.

8.4 Reagent Exchange Adapter Maintenance

The Reagent Exchange Adapter should be cleaned if excessive liquid and/or salts have built on the surfaces. Clean the adapter and holder if salts can be seen in or near the ground-glass joint. To clean the adapter:

1. Loosen the caps and remove the tubes from the adapter. Make sure that the bottled end of the tubes are not immersed in liquid to avoid spillage.
2. Remove the Reagent Exchange Adapter from the top of the holder.
3. Disconnect the caps from their threads.
4. Rinse the adapter, o-rings, and caps (if necessary) with dry methanol. If needed, use soap and water, then rinse with methanol.

5. Wipe joint grease off of the ground-glass joints with a clean, dry cloth or tissue.
6. Dry the glass adapter in a drying oven, or thoroughly wipe dry. Allow that caps and o-rings to air dry.
7. Ensure that all pieces are thoroughly dry before re-assembly.

8.5 Peripherals

Warning! *Connection/disconnection of POWER CORD, PUMP ASSEMBLY, EXTERNAL PC DISPLAY, PRINTER, RS232 INTERFACE or EXPANSION DEVICE must be done only when titrator and external devices are turned off.*

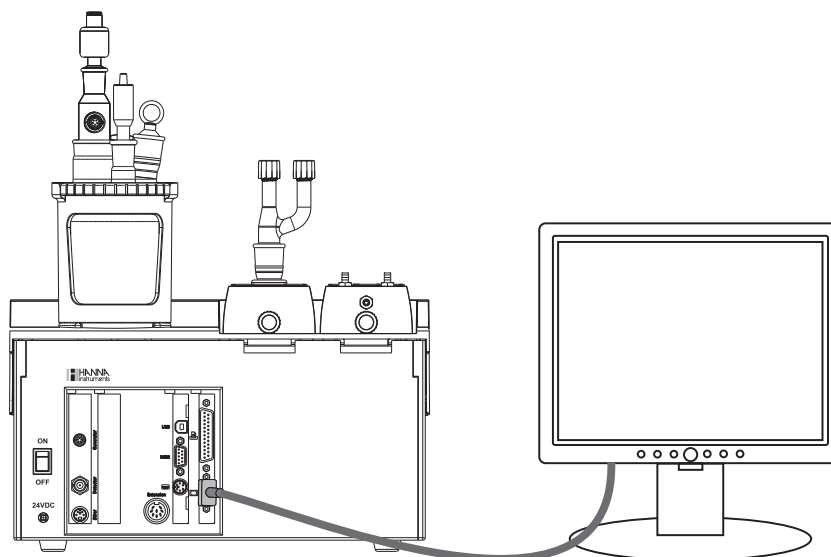

8.5.1 Connecting an External Display

The information shown on the titrator display can be viewed also on a Standard VGA display connected with a 15-pin cable, as presented below.

Connect the external display to the display socket.
Turn on the titrator and then the external display.

MAINTENANCE, PERIPHERALS

8.5.2 Connecting an External PC Keyboard





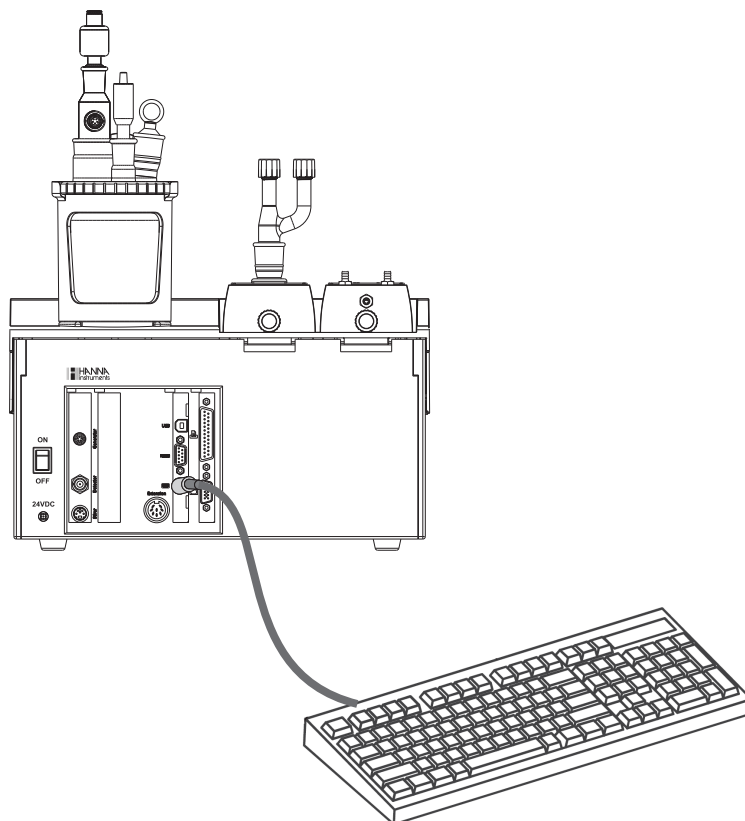









This connection allows you to use an external PS/2 PC Keyboard in addition to titrator's keypad.

Connect an external PC Keyboard (PS/2 connector).



MAINTENANCE, PERIPHERALS

The correspondence between the Titrator's Keypad and the United States 101-type external keyboard are:

External PC Keyboard (United States 101)	Titrator Keypad
Function Key F-1	
Function Key F-2	
Function Key F-3	
Function Key F-4	
Function Key F-5	Option Key 1 (from left to right)
Function Key F-6	Option Key 2 (from left to right)
Function Key F-7	Option Key 3 (from left to right)
Function Key F-8	Option Key 4 (from left to right)
Function Key F-9	Option Key 5 (from left to right)
Function Key F-10	
Arrow Key: Up	
Arrow Key: Down	
Arrow Key: Left	
Arrow Key: Right	
Page Up	
Page Down	
Numeric Keys: 0 to 9	
Tab	
Enter	
Home (access <i>General Options</i>)	
Alphanumeric Keys	Allow alphanumeric entries.

MAINTENANCE, PERIPHERALS

8.5.3 Connecting a Printer

A variety of parallel printers can be connected to the parallel port of the titrator using a standard DB-25 cable.

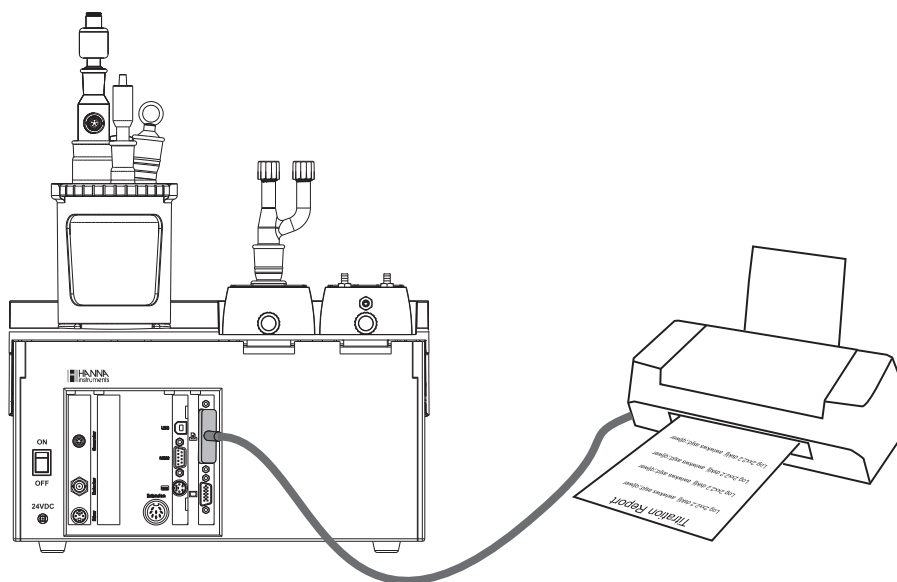

Warning: The titrator and the external printer must both be OFF before they are connected.

Connect the external printer to the standard 25-pin Socket.
Turn on the titrator and then the printer.

8.5.4 Connecting to a Computer

The titrator can be connected to a computer using a USB cable. **HI 900** PC application needs to be installed on the PC.

Connect the cable to the USB port on the rear panel of the titrator.

Connect the cable to the USB port on the PC.

Select the **USB Link with PC** screen on the titrator by following the path:

General Options - USB Link with PC

Launch the **HI 900** PC application and then select the appropriate USB port on the PC.

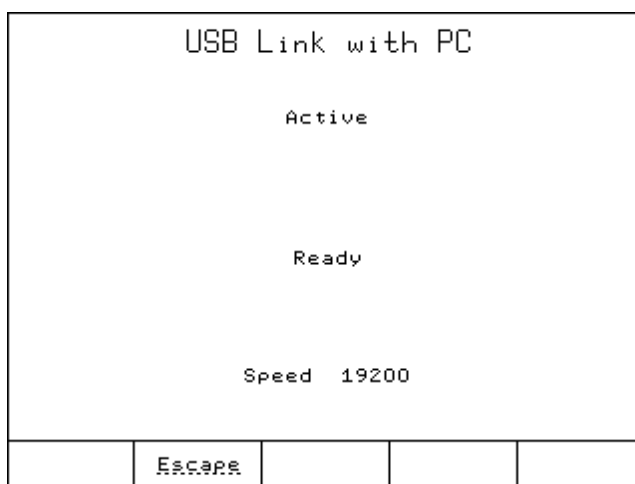

The **HI 900** PC application allows the transfer of files (methods and reports) between titrator and PC.

Chapter 9. Contents

9	OPTIMIZATION	9 - 3
9.1	Titrator Settings	9 - 3
9.1.1	Control Parameters.....	9 - 3
9.1.1.1	Endpoint Potential and Polarization Current	9 - 3
9.1.1.2	Titration Speed	9 - 4
9.1.1.3	Signal Averaging	9 - 4
9.1.2	Termination Parameters	9 - 5
9.1.2.1	Stability Time	9 - 5
9.1.2.2	Drift Stop Termination Criteria	9 - 5
9.1.2.2.1	Relative Drift Stop	9 - 5
9.1.2.2.2	Absolute Drift Stop	9 - 6
9.1.3	Method Options	9 - 6
9.1.3.1	Pre-Analysis Stir Time	9 - 6
9.1.3.2	Stirring Speed	9 - 6
9.1.3.3	Background Drift Rate Entry.....	9 - 6
9.2	The Sample	9 - 7
9.2.1	Proper Sampling Procedure	9 - 7
9.2.2	Determining the Optimal Sample Size	9 - 7
9.2.3	Solid Samples.....	9 - 7
9.2.4	Liquid Samples	9 - 8

METHODS OPTIMIZATION

9.2.5 Sample Preparation Techniques	9 - 9
9.2.5.1 Dilutions	9 - 9
9.2.5.2 External Dissolution	9 - 9
9.2.5.3 External Extractions	9 - 9
9.2.5.4 Homogenization	9 - 10
9.2.5.5 Heating	9 - 10
9.3 Karl Fischer Reagent System	9-11
9.3.1 Water Standards	9 - 11

9 OPTIMIZATION**9.1 Titration Settings**

This section provides the descriptions of critical titration parameters necessary for an analyst to modify a standard method or develop a titration method from scratch.

HI 904 methods can be modified and customized based on the requirements of the sample, sample matrix and the Karl Fischer reagent formulation. The user changeable settings are separated into two categories: Control Parameters, which set critical functions that determine the course of a titration and set the way in which titrations are terminated, and Method Options, which control lesser features not directly affecting measurements and primarily allow advanced users to shorten titration times.

9.1.1 Control Parameters**9.1.1.1 Endpoint Potential and Polarization Current**

The **HI 904** uses the polarized electrode system known as bivoltametric indication. The titrator monitors the voltage required to maintain a pulsed polarization current (I_{pol}) between the pins of a dual platinum-pin Karl Fischer electrode during the course of a titration.

During a titration, no excess iodine is present. In order to maintain the set polarization current the **HI 904** must apply a relatively large voltage across the pins of the electrode.

At the endpoint of the titration, the amount of iodine added is equal to the amount of water from the sample. When an excess of iodine has been generated the excess iodine is easily reduced, and the resulting iodide is easily oxidized in electrode reactions at the cathode and anode respectively. The ease of these reactions make maintaining the polarization current possible at a much lower electrode potential.

In theory, a large shift in the electrode potential indicates the endpoint. In practice, a titration endpoint is reached when the electrode potential drops below a value defined by the user and the chosen termination criteria is met.

The choice of endpoint potential should be based, foremost, on the polarization current and, to a lesser extent, on the composition of the Karl Fischer reagent and the sample matrix. If the polarization current is changed, the endpoint potential must also be changed. In addition, there are pitfalls to be avoided when choosing an endpoint potential. Selecting endpoints which are both 'too high' or 'too low' will result in long titration times and poor reproducibility. Endpoints which are 'too high' are those which result in endpoints that either precede or coincide with equivalence point such that the concentration of excess iodine is not reliably detected. Endpoint potentials are considered 'too low' when they correspond to a large excess of iodine in the titration cell.

METHODS OPTIMIZATION

The table that follows correlates endpoint potential ranges for each of the possible polarization current settings of the **HI 904**. The suggested endpoints below are applicable for reagents formulated with methanol. Endpoint potentials should be increased by 20 to 25% when titrating with reagent systems formulated for use with aldehydes or ketones or where methanol has been replaced with higher alcohols or substituted ethers like diethylene glycol monoethyl ether or 2-methoxyethanol.

Polarization Current	1 μ A	2 μ A	5 μ A	10 μ A
Endpoint Potential	30 to 90 mV	90 to 130 mV	140 to 180 mV	200 to 300 mV

Note: *Cleaning the detector electrode with cleaning agents will remove platinum-iodine complexes that have formed on the electrode surface. This will lower the resistance of the detector and therefore lower the detector's mV readings. To counteract this change, lower the endpoint mV value, or raise the imposed current under Method Options. The platinum-iodine complex will reform after several titrations.*

9.1.1.2 Titration Speed

The **HI 904** predicts the approaching endpoint and reduces the volumes of titrant added until the endpoint is reached. This is a software controlled process known as dynamic dosing. Dynamic dosing prevents the addition of titrant beyond the endpoint and provides enhanced data density in the vicinity of the endpoint resulting in accurate endpoint determination and faster titrations. The minimum and maximum dose volume must be set appropriately by the user for dynamic dosing to be effective.

The Titration Speed setting controls the rate of iodine generation. Faster titration speeds will reduce the titration time, but will increase the chance of over-titration. Slower titration speeds will allow greater endpoint accuracy, but will lengthen the titration time. The recommended titration speed for each sample depends on the amount of water introduced by the sample:

Titration Speed	Slow	Normal	Fast
Sample Moisture	< 300 μ g	300 - 1000 μ g	1000 μ g

If Automatic is selected, the **HI 904** will determine the appropriate titration speed based on the estimated water content and the amount of sample added to the vessel for each titration. If over-titration frequently occurs, select a slower titration speed. If a shorter titration duration is desired, select a faster titration speed.

9.1.1.3 Signal Averaging

The chosen value for the signal averaging setting determines how many readings the electronics will average to produce a single data point on the titration curve. While higher values of 3 or 4 readings reduce the response time of the electrode, they also result in a 'smoother' titration curve which may result in a faster titration (single unstable readings may cause the dose size to be reduced).

9.1.2 Termination Parameters

HI 904 provides a choice of three criteria by which a titration can be considered to have reached an endpoint successfully.

9.1.2.1 Stability Time

When this termination criteria is selected, a titration is considered to have reached an endpoint when the electrode potential stays below the specified endpoint potential for a period of time called the stability time. Typical endpoint stability times range between 5 and 15 seconds.

9.1.2.2 Drift Stop Termination Criteria

Drift-based termination criteria, or Drift stop, terminates titrations based on the idea that at the end of a titration, when all of the water due to the sample has been reacted, the titrator should only be titrating the water seeping into the cell due to the background drift rate (see section 6.3 for a detailed explanation of background drift).

Ideally, drift stop termination criteria would end a titration when a drift rate identical to that which preceded the start of a titration is observed at the end of a titration. However, from a practical standpoint the achievement of an identical drift rate results in very long titration times.

In order to shorten titration times while still taking advantage of the positive aspects of drift-based termination, the **HI 904** incorporates two drift stop termination criteria which terminate titrations when the drift rate passes below a specified threshold. The methods can be distinguished by the way in which the drift rate thresholds are specified.

9.1.2.2.1 Relative Drift Stop

The relative drift stop termination parameter should be the first choice termination criteria. It is the most universally applicable, easiest to use and results in fast, repeatable titrations.

This parameter has the advantage over other termination criteria in that the relative drift rate termination value can be set independently from the initial drift rate.

Under this criteria, a titration reaches an endpoint successfully when the **HI 904** titrates all of the water introduced with the sample and maintains a drift rate which is equal to the sum of the initial drift (drift rate when the titration was initiated) and the set 'relative drift stop' value (i.e. a slightly higher drift than the initial drift rate).

The choice of relative drift stop value influences the titration duration and reproducibility. Choosing low relative drift stop values (3 to 5 $\mu\text{g}/\text{min}$) will result in titrations with high reproducibility and long durations. Setting high relative drift stop values (8 to 15 $\mu\text{g}/\text{min}$) will result in fast titrations with potentially reduced reproducibility.

Lower relative drift stop values are required for low-concentration samples. The last few micrograms of water from a sample are slow to react with iodine. Therefore, it is critical to allow the last few micrograms time to react since it may be a significant portion of the total titrated water. For titrations of less than 200 μg water, it is recommended to set the relative drift stop to 3-4 $\mu\text{g}/\text{min}$. Titrations of greater than 200 μg water can have a relative drift stop of 8 to 15 $\mu\text{g}/\text{min}$.

METHODS OPTIMIZATION

9.1.2.2.2 Absolute Drift Stop

Under this criteria, a titration reaches an endpoint successfully when the drift falls below a predefined threshold called the absolute drift stop value.

When setting the absolute drift threshold, a balance must be struck between the titration speed and accuracy. Choosing a threshold slightly higher than the initial drift rate will result in high reproducibility and relatively slow titrations. Setting the threshold higher (>30 mg/min) will result in very fast titrations and reduced titration reproducibility.

The current drift rate must be considered before selecting an absolute drift stop value. Setting to low of a value relative to the starting drift rate may cause the titration to continue indefinitely without reaching a valid endpoint.

9.1.3 Method Options

9.1.3.1 Pre-analysis Stir Time

When analyzing samples with limited miscibility or release water slowly, the sample must be stirred prior to the start of a titration, to avoid erroneously low titration results or unreachable endpoints. The pre-analysis stir time option ensures that after the sample is added, the titration mixture is stirred for a period of time before any iodine is generated in the cell. The pre-analysis stir time can be set between 0 and 1000 seconds.

9.1.3.2 Stirring Speed

The **HI 904**'s stirring speed can be set between 200 and 2000 RPM with 100 RPM resolution. The stirring system is equipped with an optical feedback mechanism to ensure that the stirring motor is rotating at the speed set by the user.

The optimum stirring speed is obtained when a small vortex is visible. If the stirring speed is too low, the titrant will not react with the sample before reaching the electrode resulting in over-titration and poor titration reproducibility. If the stirring speed is too high, bubbles will form in the solution. Bubbles can destabilize or falsify the measured electrode potential.

The default stirring speed for commercially available standard Karl Fischer reagents used within the operable volume range of the standard Hanna Instruments cell and with the supplied magnetic stirring bar is 900 RPM. As the liquid level within the titration vessel increases, it may be necessary to increase the stirring speed to sufficiently mix the solution.

9.1.3.3 Background Drift Rate Entry

This option provides a choice between the **HI 904**'s automatic drift rate determination and assigning a fixed value to be used by the titrator as the drift rate.

The primary benefit of bypassing the automatic drift rate feature is saving time. This is appropriate when titrating samples with high water content where the drift rate is too low to affect titration results or in diagnostic situations where there is no advantage in waiting for the **HI 904** to conduct a drift rate analysis.

9.2 The Sample

9.2.1 Proper Sampling Procedure

Proper sampling is essential for accurately determining the water content of bulk materials, particularly with non-homogeneous samples. Many standard methods detail instructions to ensure proper sampling. As a general rule, the following guidelines should be followed:

1. The sample must be representative. The water content of the sample taken is the same as the average water content of the bulk material.
2. Avoid exposing samples to the contaminating effects of atmospheric moisture. Take samples as quickly as possible and protect the sample during transport and/or storage.
3. Take samples from the interior of bulk materials. Surfaces of hygroscopic materials may contain higher levels of moisture relative to the rest of the material. Surfaces of materials which release water may contain less water relative to the rest of the material.
4. Taking large samples of bulk materials will result in a more representative sample.

9.2.2 Determining the Optimal Sample Size

The **HI 904** titrates optimally in the range of 0.5 to 2.0 mg water per sample. Ideally, the sample size would be scaled to always be in this range, but it becomes impractical to add the large sample sizes that would be required for concentrations of 500 ppm and lower. Attempting to add more than 10 g of sample increases the chance of erroneous results due to the sample significantly changing the composition of the reagent. In addition, the titration vessel will quickly fill after a couple of titrations if the sample size is 10 g. For samples below 500 ppm, the sample size should be a balance between titration accuracy (bigger sample size) and economy (less reagent waste). The following table shows the recommended sample size based on the moisture content:

Water Content	1 ppm	20 ppm	100 ppm	250 ppm	1000 ppm	1 %	5 %
Sample Size	10 g	5 g	3 g	2 g	1 g	0.1 g	0.02 g

9.2.3 Solid Samples

Solid samples should never be analyzed directly in the titration vessel. Solids greatly increase the risk of clogging the diaphragm of the generator, which could cause permanent damage. In addition, opening the titration vessel in order to add a solid sample would introduce a significant amount of moisture causing false high readings and increasing the drift between titrations. These samples should be analyzed by either external extraction or external dissolution.

METHODS OPTIMIZATION

9.2.4 Liquid Samples

The water contained in liquid samples must be available to react with the KF reagent. It is important to select a reagent or co-solvent with which the sample is miscible.

Liquids are typically added through the septum in the sample port via a syringe and needle using the following steps:

1. Attach a long needle (approximately 6" long, 21-gauge) to a syringe large enough to hold at least one complete sample volume.
2. Rinse the syringe and needle with sample several times by drawing in a small portion of sample, fully extending the plunger, shaking to coat the syringe interior and expelling the sample into a waste collection container.
3. Draw enough sample into the syringe for at least one titration.
4. Dry the outside of the needle with a lint free wipe or tissue.
5. Determine the mass of the syringe and sample.
6. Initiate a titration from standby mode by pressing the 'start analysis' option key.
7. Insert the needle through the septum in the sample port. Push the syringe through the septum until the end of the needle is approximately 1 cm from the surface of the solvent.
8. Steadily dispense the contents of the syringe ensuring that the sample is introduced directly into the solvent and does not splash or spatter onto the wall of the titration vessel electrode or dispensing tip.
9. Draw a small amount of air from inside the cell into the syringe to ensure that no sample drops remain on the tip of the needle.
10. Remove the syringe and needle from the septum taking care to not touch the needle to the solvent or other internal cell components.
11. Determine the mass of the syringe and needle.
12. Calculate the mass of the sample added to the titration cell (subtract the mass of the syringe after the sample has been added from the mass of the syringe before sample addition).
13. Enter the calculated mass of the sample into the **HI 904**.
14. Start titration using the option key 'start analysis' from the add sample screen.

As indicated above, when adding a liquid sample with a needle and syringe, it is important that the sample is introduced directly into the solvent. Sample that is deposited on the sides of the vessel or other internal components of the cell may not be titrated with the rest of the sample. It is equally important that no drops remain on the tip of the needle. 'Hanging drops' will end up on the bottom of the septum. This will result in false low results for the determination. Liquid samples with high viscosity may be carefully warmed to improve the flow through the needle.

In some cases liquid samples may require one of the additional preparatory steps listed in the sections that follow. Specific sample preparation instructions are included with each standard method.

9.2.5 Sample Preparation Techniques

While many samples can be introduced directly into the titration vessel (see section 6.5 *Sample Addition*), others require preparatory steps. It is critical that samples are not contaminated with additional water or lose water during the preparation phase.

The steps required for the most common sample preparation techniques are outlined below. For detailed application-specific instructions, consult the instructions included with applicable standard methods.

The **HI 904** provides options for the automatic calculation of samples prepared normally, using external extraction and external dissolution.

9.2.5.1 Dilutions

It is very difficult to accurately add very small amounts of sample to the titration vessel. In order to produce accurate and reproducible results, samples having water content greater than 5% should therefore be diluted with a dry solvent before being introduced into the titration vessel. Dilutions are carried out using the 'external dissolution' sample type option.

Anhydrous methanol is the solvent of choice for sample dilutions. If the sample contains fats or oils, then a mixture of methanol and chloroform can be used to promote solubility of the sample.

The following outlines a generic dilution procedure:

1. Determine the mass of a dry flask equipped with a septum stopper.
2. Transfer approximately 1 g of sample to the flask and measure the mass of the flask and the sample together.
3. Add 30 grams of dilution solvent to the flask. Re-seal and mix the flask contents.
4. Determine the moisture content of the dry solvent used as the diluent in a separate titration.
5. Add the diluted sample as per the instructions for adding liquid samples in this section.

9.2.5.2 External Dissolution

External dissolutions are used for all solid samples or mixed-phase samples that will dissolve in a solvent mixture.

Sample preparation and choice of solvent or solvent mixture is sample specific. Consult an applicable standard method for procedural details.

The **HI 904** will conduct the necessary calculations automatically when 'external dissolution' is selected from the sample type menu.

9.2.5.3 External Extraction

External extraction is used for all insoluble solid samples.

The **HI 904** will conduct the necessary calculations automatically when 'external extraction' is selected from the sample type menu.

METHODS OPTIMIZATION

An outline of a general procedure follows:

1. Determine the mass of an extraction bottle or flask equipped with a septum.
2. Add the extraction solvent to the bottle and determine the mass of the bottle and the solvent. In order to maximize the effectiveness of the extraction, the water content of the solvent should be as low as possible. When choosing an extraction solvent, one must carefully consider the limit of water saturation for a possible solvent.
3. Determine the water content of the solvent.
4. Determine the mass of the solvent remaining in the extraction bottle.
5. Add a finely crushed sample to the solvent in the extraction bottle. The amount of sample added should be large enough so that the amount of water in the sample is much greater than that in the solvent before the extraction.
6. Facilitate extraction by shaking the solution or placing the solution on a stirring plate or in a sonicator.
7. Allow the insoluble portion of the sample to settle to the bottom of the extraction bottle.
8. Titrate an appropriately sized sample of the supernatant (solvent above the settled solid sample).

9.2.5.4 Homogenization

Homogenization is recommended for non-aqueous or mixed phase liquid samples as well as solids with inhomogeneous distributions of water. Water can be evenly distributed throughout a collected sample by the use of high speed, high shear mixers called homogenizers.

In mixed phase (oil and water) non-aqueous samples, water tends to migrate to the surface of the sample solution, adhere to the inner walls of or sink to the bottom of the sample bottle. This is particularly problematic when sampling is done at high temperatures and the specimen is subsequently allowed to cool to room temperature prior to analysis.

Solid samples typically exhibit inhomogeneous water distributions and must therefore be thoroughly reduced to powder or homogenized. The procedure for homogenization depends upon the characteristics of the specific sample.

Homogenization is particularly suited for semi-solid samples and suspensions and is the only method that can disrupt plant and tissue cells in order to release water present inside the cells. Homogenization is typically carried out externally in a dry flask with the addition of a suitable solvent, preferably methanol.

9.2.5.5 Heating

Sample heating is used for the analysis of solid or liquid samples that cannot be extracted or that interfere with the Karl Fischer reaction. These include plastics, minerals, petrochemical products which contain additives, and starting materials for pharmaceutical products.

Samples are heated in a special oven while a dry stream of carrier gas passes through the sample chamber or, for liquid samples, the sample itself. The carrier gas is introduced into the titration vessel.

The heating temperature is sample specific and can be found in applicable standard methods. The temperatures are chosen to be as high as possible without decomposing the sample, which can result in contamination of the titration vessel.

9.3 Karl Fischer Reagent System

A wide variety of Karl Fischer reagents exist on the market today, each designed and formulated for specific sample matrices and titration conditions.

Coulometric Karl Fischer reagent systems consist of an anolyte and a catholyte. Reagents for diaphragm-less generators are single-reagent systems. The reagent manufacturer will specify if a specific reagent is suitable for cells with diaphragm or without diaphragm (or both). For reagents requiring a diaphragm, the manufacturer will also supply a suitable catholyte. Commercial reagents are typically formulated for one of the following applications:

- General Purpose
- Ethanol-based
- Ketone/Aldehyde
- Oil/Hydrocarbons

Consult a Standard Method or reagent manufacturer for appropriate reagents for an application.

9.3.1 Water Standards

Water standards are used to verify the titrator's performance and analyst technique. Water standards are an integral part of ISO 9000, GMP, GLP and FDA guidelines for water determination.

Water standards are available commercially in single-use sealed ampoules. Concentration values are typically 0.1, 1.0, and 10.0 mg/g and are certified by the manufacturer. Coulometry is an absolute method that does not require calibration or titer determination, but it is useful to occasionally titrate water standards as a system check. This will confirm that there are no issues with the method settings, reagents, sample addition technique, or the titrator electronics.

General procedure using a liquid water standard (ampoule):

1. Setup titrator according to the instruction manual. Ensure the titrator is set up with the same reagent, working conditions, temperature and titrator settings to be used for subsequent sample analyses.
2. Select an appropriate standard that closely matches the sample's water content.
3. Break open an ampoule of standard. Rinse a syringe with a small portion of standard.
4. Draw up the remainder of the standard into the syringe, weigh and titrate about one-third of the standard in the syringe.
5. Conduct two more titrations with the standard remaining in the syringe.
6. Review the set of results on the 'average results' statistics screen. The average standard concentration should be within the range specified on the Certificate of Analysis provided by the manufacturer. There should not be excessive variability between each result.

MAN HI904
09/13

Appendix 1. Contents

A1 TECHNICAL SPECIFICATIONS A1-3

A1 TECHNICAL SPECIFICATIONS

Range	1 ppm to 5%
Resolution	0.1 ppm
Result Units	%, ppm, mg/g, µg/g, mg, µg, mg/mL, µg/mL, ppt, mgBr/100g, gBr/100g, mgBr, gBr
Sample Type	Liquid or Solid* (external dissolution/extraction)

Determination

Pre-Titration Conditioning	Automatic
Background Drift Correction	Automatic or User Selectable Value
Endpoint Criteria	Fixed mV persistence, Relative drift stop or Absolute drift stop
Dosing	Dynamic with 3 speed settings
Result Statistics	Mean, Standard Deviation

Titration Vessel

Type	Borosilicate glass with standard taper glass joint connections
Operating Volume	100 - 200 mL
Septum	Silicone rubber
Septum Cap Thread	GL-18
Reagent Port	Standard Taper 19

Detector Electrode

Type	Dual platinum pin, polarization electrode
Electrical Connection	BNC
Glass Connection	Standard Taper 14/20
Polarization Current	1, 2, 5, 10 µA
Voltage Range	2 mV to 1100 mV
Voltage Resolution	0.1 mV
Accuracy	± 0.1%

Generator Electrode

Type	Diaphragm or Diaphragm-less
Electrode Type Detection	Automatic
Electrical Connection	5-pin connector with detachable cable
Glass Connection	Standard Taper 29/12
Maximum Current	400 mA
Current Control	Automatic or Fixed (400 mA)

Stirrer

Type	Magnetic, Optically regulated, digital stirrer
Speed	200- 2000 RPM
Resolution	100 RPM
External Stirrer	4-pin mini DIN Connection allows for the control of an external stirring apparatus

APPENDIX 1

Reagent Handling System

Type	Sealed system with integrated diaphragm air pump
Desiccant Type	Molecular Sieves
Bottle Thread Type	GL-45
Glass Connection	Standard Taper 19 (using supplied adapter)
Reagent/Waste Tubing	PTFE

Peripheral Devices

PC	Transfer methods and reports via USB connection to a PC using the HI 900 PC Software
USB Flash Drive	Methods and reports can be easily transferred between devices using a USB Flash Drive. Software upgrades are made easy.
Laboratory Analytical Balance	RS-232 to connect any laboratory balance
Printer	Parallel port is used to connect a printer which allows printing from the titrator
Monitor	Instrument status and titrations can be viewed on a larger screen using any VGA-compatible external monitor
Keyboard	Alphanumeric text can be entered using an optional PS/2 keyboard

Graphic Display 5.7" (320 x 240 Pixel) Color LCD

Power Supply 100-240 Vac, 50/60 Hz

Power Draw 0.6 Amps

Languages English, Portuguese, Spanish, French

Titration Methods Up to 100 (standard and user) methods

Data Storage Up to 100 complete titration reports and drift rate reports can be stored

GLP Conformity Good Laboratory Practice and Instrumentation Data Storage and printing

Enclosure Material ABS plastic and Steel

Keypad Polycarbonate

Dimensions Width x Depth x Height = 390 x 350 x 380 mm
(15.3 x 13.8 x 14.9 in)

Weight Approx. 22 lbs. (10 kg)

Operating Environment 10 to 40°C, up to 80% relative humidity

Storage Environment -20 to 70°C, up to 95% relative humidity

Appendix 2. Recommended Reagents

A2 RECOMMENDED REAGENTS A2-3

A2.1 Reagents for Generators with Diaphragm A2-3

A2.2 Reagents for Generators without Diaphragm A2-3

A2.3 Water Standards A2-3

A2 RECOMMENDED REAGENTS**A2.1 Reagents for Generators with Diaphragm**

Sigma-Aldrich® HYDRANAL®

34836 Coulomat AG (anolyte)	34840 Coulomat CG (catholyte)	General Purpose
34726 Coulomat E (anolyte)	34840 Coulomat CG (catholyte)	Ethanol-based
34868 Coulomat Oil (anolyte)	34840 Coulomat CG (catholyte)	Hydrocarbons/Oils
34843 Coulomat AG-H (anolyte)	34840 Coulomat CG (catholyte)	Hydrocarbons/Oils
34820 Coulomat AK (anolyte)	34821 Coulomat CG-K (catholyte)	Ketones/Aldehydes

A2.2 Reagents for Generators without Diaphragm

Sigma-Aldrich® HYDRANAL®

34836 Coulomat AG	General Purpose
34726 Coulomat E	Ethanol-based
34843 Coulomat AG-H	Hydrocarbons/Oils
34820 Coulomat AK	Ketones/Aldehydes
34810 Coulomat AD	Dedicated for cell

A2.3 Water Standards

Sigma-Aldrich®	HYDRANAL®	34847 Water Standard 0.1
		34828 Water Standard 1.0

Appendix 3. Accessories

A3 TITRATOR COMPONENTS A3-3

A3 TITRATOR COMPONENTS

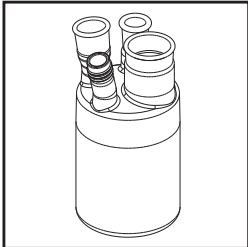

HI 900561
Titration Vessel
(Glass only)

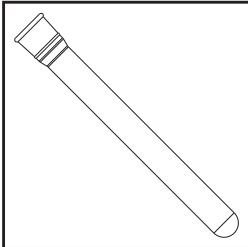

HI 900182
Reagent Adapter
Holder (Glass only)

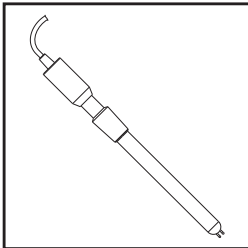

HI 76330
Detector Electrode

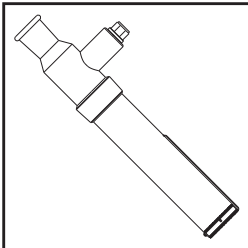

HI 900511
Generator Electrode
with Diaphragm

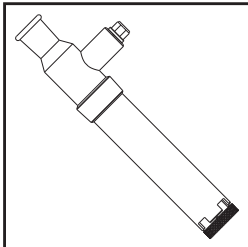

HI 900512
Generator Electrode
without Diaphragm

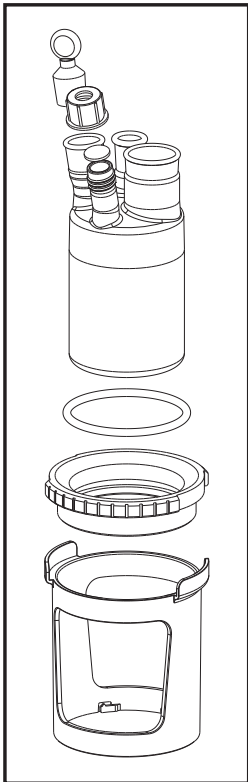

HI 900560
Titration Vessel
Assembly

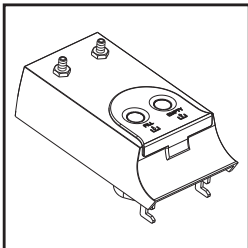

HI 900180
Air Pump

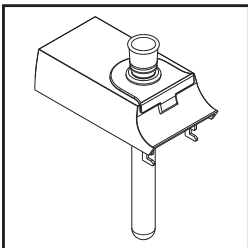

HI 900181
Reagent Adapter
Holder Assembly

APPENDIX 3

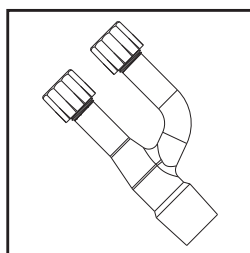

HI 900568
Reagent Exchange
Adapter

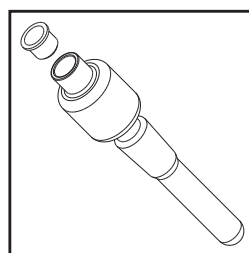

HI 900564
Desiccant Cartridge for
Generator Electrodes

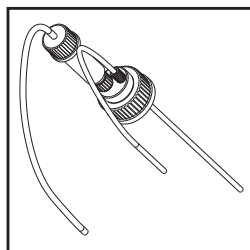

HI 900537
Bottle Top Assembly
(with molecular sieves)

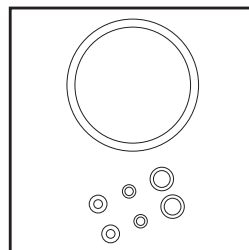

HI 900542
O-ring set

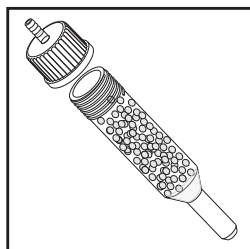

HI 900538
Desiccant Cartridge for
Reagent/Waste Bottles

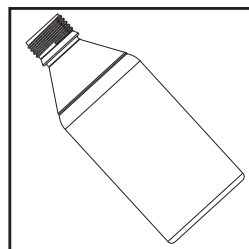

HI 900534
Waste Bottle

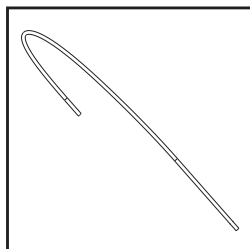

HI 900535
2 x Tubing for Reagent/
Waste Handling
HI 900536
2 x Tubing for Air Pump

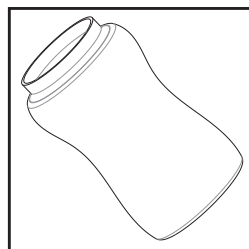

HI 900551
Molecular sieves, 150 g

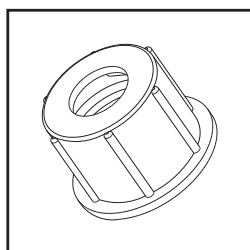

HI 900566
Open-top GL18 Cap

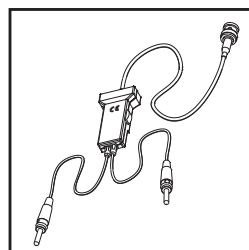

HI 900940
Calibration Key

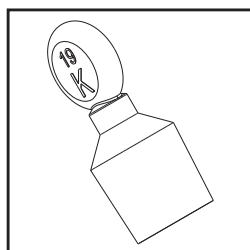

HI 900563
Glass Stopper,
Standard Taper 19

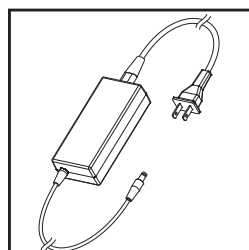

HI 900946
24 V Power Supply

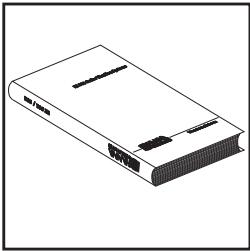

HI 900804
Manual (English) for
HI 904

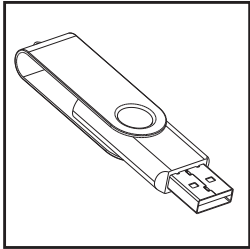

HI 900900U
PC Application on USB
Flash Drive

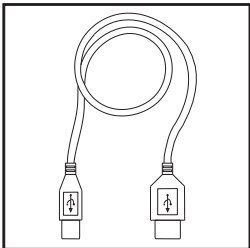

HI 920013
USB Cable

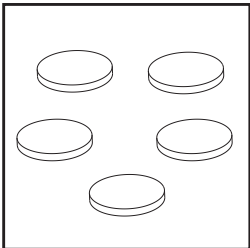

HI 900567
Septum Kit (5 pcs)

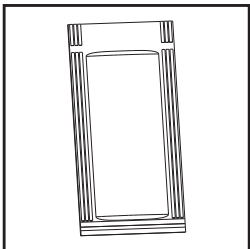

HI 900543
Glass Joint Grease

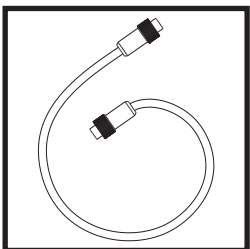

HI 900931
Generator Cable

MAN HI904
09/13

GENERAL APPLICATIONS BROCHURE

HI 904

KARL FISCHER COULOMETRIC TITRATOR

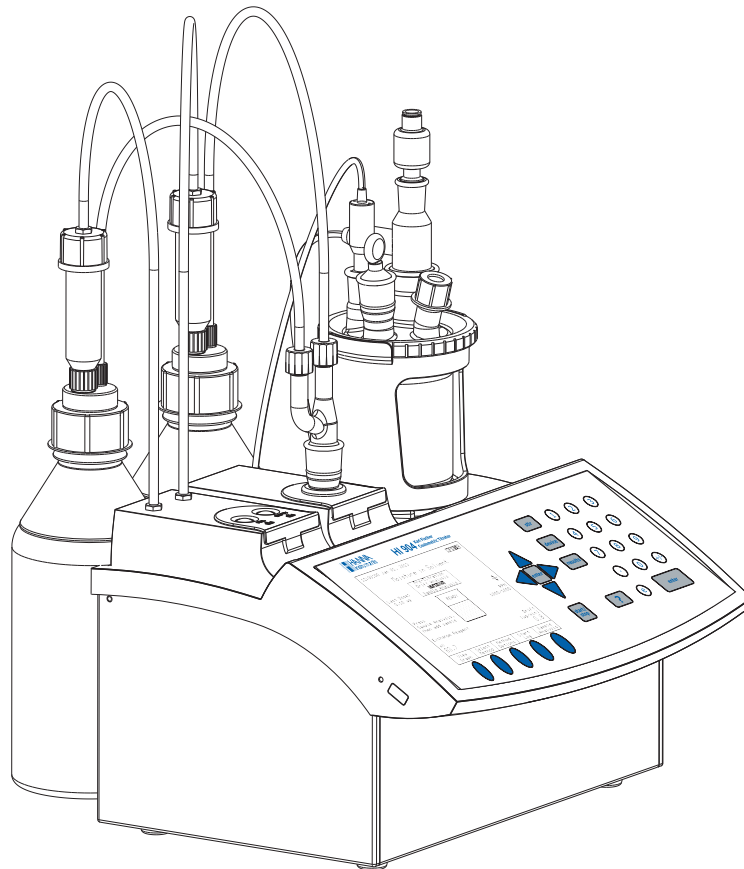

 **HANNA**[®]
instruments

www.hannainst.com

Titrator Validation with 1.0 mg/g Water Standard

Description:

Method for validation of titrator accuracy. The results are expressed in mg/g and should match the certified value (within the uncertainty limits) provided by the manufacturer of the standard.

Electrode:

- HI 76330 Double Platinum Pin Electrode
- HI 900517 Generator with Diaphragm
-or-
- HI 900518 Generator without Diaphragm

Reagents:

- General Purpose Coulometric Karl Fischer Reagent
- 1.0 mg/g Liquid Water Standard, Certified

Other Accessories:

- A clean, dry 3-mL syringe
- A clean, dry 22-gauge, 6" non-coring septum penetration needle
- GL 45-Thread Reagent Bottle

Procedure:

- Setup titrator according to the instruction manual.
- Press "*Select Method*" from the main screen. Use the arrow keys to highlight 'HI9001EN Validation-1.0mg/g Std' and press "*Select*".
- Connect the reagent bottle top assembly to the bottle of reagent according to the manual.
- Prepare the titration vessel according to the manual. Dispense enough reagent from the reagent bottle to fill the vessel to the "min" line (about 100 mL).
- Press "Start/Stop" to pre-titrate the reagent and the titration vessel moisture. Allow the background drift rate to stabilize before running a titration.
- Open an ampoule of water standard.
- Rinse the syringe and needle by in taking a small amount of standard and expelling it into a waste container.
- Fill the syringe and needle with the standard. Any unused standard remaining in the ampoule should not be used later in order to avoid contamination from atmospheric water.
- Weigh the syringe, needle and standard.
- Press "*Start Analysis*". You will be prompted to enter the sample size.
- Dispense 0.7500 g to 1.0000 g of standard (approximately 1 mL) into the titration vessel through the septum using the needle. Pay attention not to get any standard on the electrode or beaker walls. If necessary, swirl the titration vessel by hand.
- Clear the needle of residual standard by in taking a very small volume of air from the titration vessel. If a "hanging drop" of standard is seen on the end

of the needle, dip the end of the needle briefly in the solvent.

- Remove the needle from the titration vessel and weigh the syringe again in order to determine the added standard mass (by difference of the two measurements.)
- Use the numeric keypad to enter the exact weight and press "*Enter*" to start the analysis.
- At the end of the titration the "Sample Analysis Result" screen is displayed. The results are expressed in **mg/g** of water.
- Perform two more titrations with the remaining water standard in the syringe.

Method Parameters:

Name:	Validation- 1.0mg/g Std
Method Revision:	1.0
Type:	KF Coulometric
Pre-Analysis Stir Time:	5 Sec
Stirring Speed:	900 RPM
Stirbar Type:	Medium
Drift Entry:	Automatic
Reagent:	General Purpose
Sample Parameters:	
Sample Determ.:	Normal
Sample Name:	DefaultSample
Sample Type:	Mass
Sample Size:	1.0000 g
Control Parameters:	
Titration Speed:	Auto
Standby Mode:	Enabled
Standby Duration:	12:00 [hh:mm]
Imposed Current:	2uA
End Point Value:	100.0 mV
Generator Current Mode:	Auto
Signal Averaging:	2 Readings
Termination Parameters:	
Maximum Duration:	1200 sec
Maximum Titrated Water:	20.000 mg
Term. Criterion:	Relative Drift
Relative Drift:	5.0 µg/min
Result Unit:	mg/g

Calculations:

Water titrated:	H ₂ O (µg)
Final results units:	mg/g
Sample mass:	1.0000 g

$$\text{mg/g} = \frac{\text{water } (\mu\text{g})}{1.0000 \text{ g}} \times \left(\frac{1 \text{ mg}}{1000 \mu\text{g}} \right)$$

Results:

	Titration Report
Method Name:	Moisture in Solvent
Time & Date:	12:00 Jan 01, 2013
Sample Size:	0.9412 g
Drift Value:	0.8ug/min
Titrated Water:	950.02ug
Result:	1.0078mg/g
Titration Duration:	1:53 [mm:ss]
Generator Electrode Type:	HI 900518
Titration went to Completion	
Operator Name:	

Analyst Signature: _____

Moisture Determination in Solvent

for external dissolution or extraction

Description:

Method for the determination of moisture in extraction/dissolution solvent. The results are expressed in mg/g and should be less than 1.00 mg/g. Extractions/dissolutions of substances with low water contents may require very dry solvents (<0.100 mg/g).

Electrode:

- HI 76330 Double Platinum Pin Electrode
- HI 900517 Generator with Diaphragm
-or-
- HI 900518 Generator without Diaphragm

Reagents:

- General Purpose Coulometric Karl Fischer Reagent

Other Accessories:

- A clean, dry 1-mL syringe
- A clean, dry 22-gauge, 6" non-coring septum penetration needle
- GL 45-Thread Reagent Bottle

Procedure:

- Setup titrator according to the instruction manual.
- Press "*Select Method*" from the main screen. Use the arrow keys to highlight 'HI9301EN Moisture in Solvent' and press "*Select*".
- Connect the reagent bottle top assembly to the bottle of reagent according to the manual.
- Prepare the titration vessel according to the manual. Dispense enough reagent from the reagent bottle to fill the vessel to the "min" line (about 100 mL).
- Press "Start/Stop" to pre-titrate the reagent and the titration vessel moisture. Allow the background drift rate to stabilize before running a titration.
- Prepare an extraction/dissolution vessel with solvent and stir (see an applicable standard method for proper solvent amount and stirring time).
- Stop stirring the solvent in the extraction/dissolution bottle.
- Fill the syringe and needle with the extraction/dissolution solvent.
- Weigh the syringe, needle and solvent.
- Press "*Start Analysis*". You will be prompted to enter the sample size.
- Dispense 0.8000 g to 1.0000 g of solvent into the titration vessel through the septum using the needle. Pay attention not to get any sample on the electrode or beaker walls. If necessary swirl the titration vessel by hand.
- Clear the needle of residual sample by in taking a small volume of air from the titration vessel. If a "hanging drop" of solvent is seen on the end of the

needle, dip the end of the needle briefly in the solvent.

- Remove the needle from the titration vessel and weigh the syringe again in order to determine the added sample mass (by difference of the two measurements.)
- Use the numeric keypad to enter the exact weight and press "*Enter*" to start the analysis.
- At the end of the titration the "Sample Analysis Result" screen is displayed. The results are expressed in **mg/g** of water.

Method Parameters:

Name:	Moisture in Solvent
Method Revision:	1.0
Type:	KF Coulometric
Pre-Analysis Stir Time:	5 Sec
Stirring Speed:	900 RPM
Stirbar Type:	Medium
Drift Entry:	Automatic
Reagent:	General Purpose
Sample Parameters:	
Sample Determ.:	Normal
Sample Name:	Solvent
Sample Type:	Mass
Sample Size:	1.0000 g
Control Parameters:	
Titration Speed:	Auto
Standby Mode:	Enabled
Standby Duration:	12:00 [hh:mm]
Imposed Current:	2uA
End Point Value:	100.0 mV
Generator Current Mode:	Auto
Signal Averaging:	2 Readings
Termination Parameters:	
Maximum Duration:	1200 sec
Maximum Titrated Water:	10.000 mg
Term. Criterion:	Relative Drift
Relative Drift:	3.0 µg/min
Result Unit:	ppm

Calculations:

Water titrated:	H ₂ O (µg)
Final results units:	ppm
Sample mass:	1.0000 g

$$\text{ppm} = \frac{\text{water } (\mu\text{g})}{1.0000 \text{ g}}$$

Results:

	Titration Report
Method Name:	Moisture in Solvent
Time & Date:	12:00 Jan 01, 2013
Sample Size:	1.0322 g
Drift Value:	0.9ug/min
Titrated Water:	208.10 ug
Result:	200.1ppm
Titration Duration:	1:45 [mm:ss]
Generator Electrode Type:	HI 900518
Titration went to Completion	
Operator Name:	

Analyst Signature: _____

Bromine Index of Aromatic Hydrocarbons

Adaptation of ASTM D1492-08

Description:

Method for the determination of bromine index of bromine-reactive substances. This method typically applies to aromatic hydrocarbons with only trace amounts of olefins (alkenes) and having bromine indexes less than 1000. For samples with a bromine index greater than 1000, it is recommended to dilute the sample with a suitable solvent.

Electrodes:

- HI 76330 Double Platinum Pin Electrode
- HI 900517 Generator with Diaphragm
-or-
- HI 900518 Generator without Diaphragm

Reagents:

- Coulometric Bromine Index Reagent without Mercury, prepared in a 1-L volumetric flask:
 - 600 mL glacial acetic acid
 - 260 mL methanol
 - 140 mL KBr solution (119 g/L)
 - Deionized water, to 1 L

Other Accessories:

- A clean, dry 1-mL syringe
- A clean, dry 22-gauge, 6" non-coring septum penetration needle
- GL 45-Thread Reagent Bottle
- 1-L volumetric flask
- 100-mL graduated cylinder

Procedure:

- Setup titrator according to the instruction manual. Remove desiccant from the desiccant cartridges on the reagent/waste bottles and on the generator.
- Press "Select Method" from the main screen. Use the arrow keys to highlight 'HI9901EN BrIndex of Aromatics' and press "Select".
- Prepare 1 L of coulometric bromine index reagent according to the Reagent List. Add to a GL 45-thread reagent bottle.
- Connect the reagent bottle top assembly to the reagent bottle according to the manual. Do not use desiccant in the desiccant cartridge.
- Prepare the titration vessel according to the manual. Dispense enough reagent from the reagent bottle to fill the vessel to the "min" line (about 100 mL).
- Press "Start/Stop" to pre-titrate the reagent.
- Fill the syringe and needle with the sample.
- Weigh the syringe, needle and sample.
- Press "Start Analysis". You will be prompted to enter the sample size.
- Enter the Estimated Bromine Index. The titrator will recommend the optimal sample size to be added to the titration vessel. Dispense the amount provided from the optimal sample size into the

titration vessel through the septum using the needle. Pay attention not to get any sample on the electrode or vessel walls. If necessary swirl the titration vessel by hand.

- Clear the needle of residual sample by in taking a small volume of air from the titration vessel. If a "hanging drop" of sample is seen on the end of the needle, dip the end of the needle briefly in the solvent.
- Remove the needle from the titration vessel and weigh the syringe again in order to determine the added sample mass (by difference of the two measurements.)
- Use the numeric keypad to enter the exact weight and press "Enter" to start the analysis.
- At the end of the titration the "Sample Analysis Result" screen is displayed. The results are expressed in **mg (Br)/100g**.

Method Parameters:

Name:	BrIndex of Aromatics
Method Revision:	1.0
Type:	Bromine Index
Pre-Analysis Stir Time:	30 Sec
Stirring Speed:	1600 RPM
Stirbar Type:	Medium
Reagent:	BrIndex Reagent
Sample Parameters:	
Sample Determ.:	Normal
Sample Name:	DefaultSample
Sample Type:	Mass
Sample Size:	0.5000 g
Control Parameters:	
Titration Speed:	Slow
Standby Mode:	Enabled
Standby Duration:	12:00 hours
Imposed Current:	10 uA
End Point Value:	300.0 mV
Generator Current Mode:	Auto
Signal Averaging:	2 Readings
Termination Parameters:	
Maximum Duration:	2400 sec
Maximum Bromine Consumed:	25.000 mg
Term. Criterion:	mV End Point
End Point Stability Time:	40 sec
Result Unit:	mg/100g

Calculations:

Bromine Consumed:	Br (mg)
Final results units:	mg/100g
Sample mass:	1.0000 g

$$\text{mg/100g} = \frac{\text{bromine (mg)}}{1.0000 \text{ g}} \times 100$$

Bromine Index of Aromatic Hydrocarbons

Adaptation of ASTM D1492-08

Results:

Titration Report

Method Name: BrIndex of Aromatics
Time & Date: 12:00 Jan 01, 2013
Sample Size: 0.4978 g
Bromine Consumed: 1.609 mg
Result: 323.33 mg/100g
Titration Duration: 4:36 [mm:ss]
Generator Electrode Type: HI 900518
Titration went to Completion
Operator Name:

Analyst Signature: _____

TITRATION THEORY
Principles
HI 904
KARL FISCHER
COULOMETRIC TITRATOR

Revision 1.0

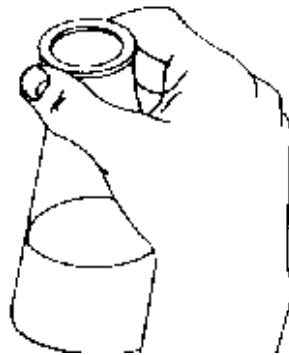
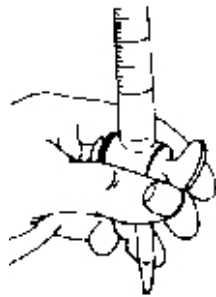

 **HANNA**[®]
instruments

www.hannainst.com

Contents

1	GENERAL REVIEW OF TITRATION THEORY	5
1.1	Introduction to Titrations	5
1.2	Uses of Titrations	5
1.3	Advantages and Disadvantages of Titrations	6
2	TYPES OF TITRATION	7
2.1	Titrations According to The Measurement Method	7
2.1.1	Amperometric Titrations	7
2.1.2	Potentiometric Titrations	7
2.1.3	Spectrophotometric Titrations	8
2.2	Titrations According to The Reaction Type	9
2.2.1	Karl Fischer Titrations	9
2.2.1.1	History of Karl Fischer Titrations	9
2.2.1.2	Volumetric Karl Fischer Titrations	10
2.2.1.3	Coulometric Karl Fischer Titrations	10
2.2.1.3.1	Generator Electrodes with Diaphragm	11
2.2.1.3.2	Generator Electrode without Diaphragm	11
2.2.1.4	Visual Indication of Karl Fisher Titrations	12
2.2.1.5	Electrometric Indication of Karl Fisher Titrations	12
2.2.2	Acid-Base Titrations	13
2.2.3	Argentometric Titrations	14
2.2.4	Complexometric Titrations	15
2.2.5	Ion Selective Titrations	15
2.2.6	Non-aqueous Solvent Acid-Base Titrations	15
2.2.7	Precipitation Titrations	16
2.2.8	Redox Titrations	16
2.3	Titrations According to The Titration Sequence	17
2.3.1	Back Titrations	17
2.3.2	Multiple End Point Titrations	17
3	INTRODUCTION TO TITRATION APPARATUS AND TYPICAL TITRATION PROCEDURE	19
3.1	Manual Titration	19
3.2	Automatic Titration	20
4	TITRATION RESULTS	21
4.1	Accuracy	21
4.2	Repeatability	21
4.3	Sources of Error	21
4.3.1	Sampling Errors	21
4.3.2	Errors with Titrant and Standard	21
4.3.2.1	Preparation Errors	21

TITRATION THEORY

4.3.2.2	Dispensing Errors.....	22
4.3.3	Chemical Reaction Errors	22
4.3.4	End Point Determination Errors	22
5	CALCULATIONS	23
5.1	Equations Used in Karl Fischer Titrations.....	23
5.1.1	Calculation of water content as % mass from samples measured by mass	23
5.1.2	Calculation of water content as % mass from samples measured by volume	23
5.1.3	Calculation of water content as % volume from samples measured by volume....	23
5.1.4	Calculation of water content as % mass subtracting Background Drift Rate	23
5.1.5	Calculation of water content in External Dissolution Samples	24
5.1.6	Calculation of water content in External Extraction Samples	24
5.1.7	Calculation of water content in Gaseous Samples	24
5.1.8	Calculation of Titer (water equivalent of the titrant) using sodium tartrate dihydrate containing 15.66% water by mass	24
5.1.9	Calculation of Titer (water equivalent of the titrant) using water standards	25
5.2	Equations Used in Titrations.....	25
5.2.1	Sample Calculation	25
5.2.2	Standardize Titrant	25
5.2.3	Blank Titration	26
5.2.4	Multiple End Point Titration	26
5.2.5	Back Titration	27
6	GLOSSARY	28

1 GENERAL REVIEW OF TITRATION THEORY

1.1 Introduction to Titrations

A titration is a quantitative, volumetric procedure used in analytical chemistry to determine the concentration of an analyte (the species being measured) in solution. The concentration of the analyte is determined by slowly adding a titrant (reagent) to the solution. As the titrant is added, a chemical reaction occurs between the titrant and the analyte.

Titration reactions are relatively fast, simple reactions that can be expressed using a chemical equation. The titration reaction continues as the titrant is added until all of the analyte is consumed and the analyte reacts completely and quantitatively with the titrant.

The point at which all of the analyte has been reacted is called the equivalence point, also known as the theoretical or stoichiometric endpoint. This point is accompanied by an abrupt physical change in the solution, which sharply defines the endpoint of the reaction. The physical change associated with the titration endpoint can be produced by the titrant or an indicator and can be detected either visually or by some other physical measurement.

Titration cannot be used to determine the quantity of all analytes. The chemical reaction between the titrant and analyte must fulfill four requirements:

- The reaction must be fast and occur within approximately one second after the titrant is added;
- The reaction must go to completion;
- The reaction must have well-known stoichiometry (reaction ratios);
- A convenient endpoint or inflection point.

Titration is highly precise and can provide many advantages over alternative methods. Titrations are quickly performed and require relatively simple apparatus and instrumentation.

1.2 Uses of Titrations

Titration can be used in many applications, including:

- Acid content of plant effluents, food (i.e. cheese and wine), plating and etching baths, petroleum products, drugs;
- Base content of fertilizer (containing ammonia), bleach, minerals;
- Hardness in water;
- Metal content of alloys, minerals, ores, clays, waters, plating baths, paints, paper, plant materials, biological fluids, petroleum products;
- Moisture content in butter, dairy cream, food grade oil, honey, margarine, mayonnaise, milk, powdered milk, sugar;
- Redox reagent concentrations such as available chlorine in potable water, peroxide, traces of oxidants and reductants in food, reductants in high temperature or high pressure boiler water, vitamin analysis.

TITRATION THEORY

1.3 Advantages and Disadvantages of Titrations

Some advantages of titrations, as an analytical technique, are:

- More precise results than many instrumental methods, such as measurement by electrode, the accuracy of the measurement is up to 0.1%;
- Simple methods, reasonable capital costs, and easy training;
- Suitability to measure major components of a mixture or product;
- Automation can reduce time and labor spent on each analysis.

Some disadvantages of titrations are:

- Time it takes to prepare standards and titrants;
- Good technique is required to achieve precise results (training and practice required);
- Not suitable for determining trace or minor components of a mixture or product;
- Limited dynamic range, it may require additional sample preparations (dilution) and repeat analyses.

2 TYPES OF TITRATIONS

2.1 Titrations According to The Measurement Method

2.1.1 Amperometric Titrations

An amperometric titration is performed by placing two electrodes (often a metal electrode and a reference electrode) into the sample solution and holding the potential of the metal electrode at a selected voltage. The current that flows, due to the oxidation or reduction of a reactant or product, is plotted vs. volume of titrant to provide the titration curve and locate the equivalence point. Changes in the current are due to changes in the concentration of a particular species (being oxidized or reduced at the electrode).

Generally the reaction between the analyte and titrant forms a new species. Depending on the titration, the reactants are electroactive and the products are not, or vice-versa. Amperometric titration curves look like two straight lines intersecting at the equivalence point, this is due to the change in the electroactivity of the solution.

Many metal ions can be amperometrically titrated using a precipitation, complexation or redox reaction. Some metal ions and species that can be determined in this manner include silver, barium, halides, potassium, magnesium, palladium, molybdate, sulfate, tungstate, zinc, bismuth, cadmium, fluoride, indium, thallium, iodine, and gold.

Figure 1 shows four amperometric titrations and their endpoints. In graph "A" the analyte is electroactive and gives current but the reacted species does not. In "B" the reactant is not active but the titrant is. In "C" both the analyte and titrant are active and both give current flow. Graph "D" shows the same situation as "B"; however, the current has an opposite sign (the titrant is reduced).

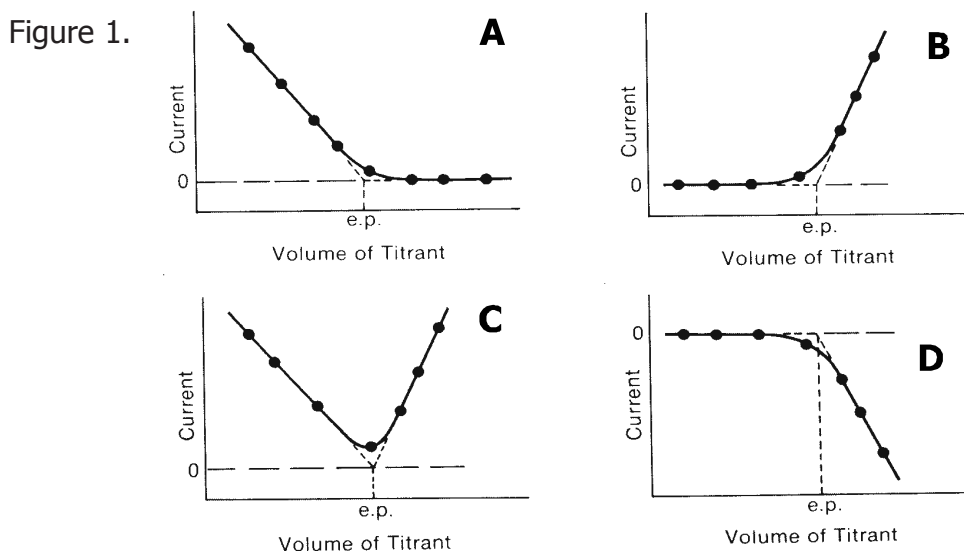

2.1.2 Potentiometric Titrations

Potentiometric titrations are done by measuring the voltage across the solution using an electrode system. An electrode system consists of an indicator electrode and a reference electrode. As titrant is added the variations in the potential of the indicator electrode, with respect to the reference electrode, are monitored to show the progress of the titration.

TITRATION THEORY

Potentiometry is the measurement of a potential under conditions of zero current flow. The measured potential can then be used to determine the analytical quantity of interest, generally a component concentration of the analyte solution. The potential that develops in the electrochemical cell is the result of the free energy change that would occur if the chemical phenomena were to proceed until the equilibrium condition has been satisfied.

There are many types of titrations where potentiometry can be used, e.g., pH electrodes for acid-base titrations, platinum ORP electrodes in redox titrations, ion selective electrodes, such as chloride or fluoride for a specific ion titration, and silver electrodes for argentometric (silver-based) titrations.

2.1.3 Spectrophotometric Titrations

The name comes from the method used to detect the endpoint of the titration, not its chemistry. Highly colored indicators that change color during the course of the titration are available for many titrations. More accurate data on the titration curve can be obtained if the light absorption is monitored instrumentally using a light source, a simple monochromator and a photodetector, rather than visually determining the color or light absorption change. Light absorption by either an indicator or by one of the reactants or products can be used to monitor the titration.

In the first titration curve, Figure 2 "A", the absorption of a metal-indicator complex is being monitored. The absorption is constant while the metal is complexed by the EDTA titrant. The metal indicator complex was stripped, causing a sharp break in the titration curve. The point where all the metal is complexed and stripped from the indicator is the equivalence point. This point is marked by "e.p." on the graph.

In the second titration curve, Figure 2 "B", the metal complex is being measured while being titrated with EDTA. The new complex being formed is not colored and does not absorb light. The extrapolated intersection of the two lines determines the equivalence point.

Figure 2.

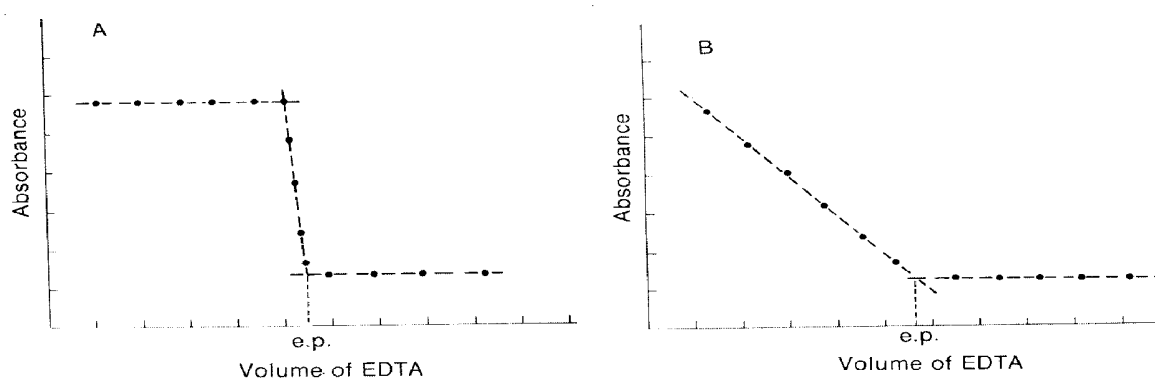

2.2 Titrations According to The Reaction Type

2.2.1 Karl Fischer Titrations

This method is based on a well-defined chemical reaction between water and the Karl Fischer reagent. The chemistry provides excellent specificity for water determination. The method can be used to determine free and bound water in a sample matrix. The Karl Fischer method is widely considered to produce the most rapid, accurate and reproducible results and has the largest detectable concentration range spanning 1 ppm to 100%.

The determination of water content is one of the most commonly practiced methods in laboratories around the world. Knowledge of water content is critical to understanding chemical and physical properties of materials and ascertaining product quality. Water content determination is conducted on many sample types including pharmaceuticals and cosmetics, foods and natural products, organic and inorganic compounds, chemicals, solvents and gases, petroleum and plastic products as well as paints and adhesives. The KF method is verifiable and can be fully documented. As a result, Karl Fischer titration is the standard method for analysis of water in a multitude of samples as specified by numerous organizations including the Association of Official Analytical Chemists, the United States and European Pharmacopoeia, ASTM, American Petroleum Institute, British Standards and DIN.

2.2.1.1 History of Karl Fischer Titrations

Water determination by Karl Fischer titration is based on the reaction described by Bunsen in 1853 in which sulfur dioxide is oxidized by iodine in the presence of water.



In Karl Fischer's 1935 article, "a new procedure for the titration of water," he presented a modified form of the Bunsen reaction adapted for use in determining the water content of non-aqueous solutions. His titrations were conducted in methanol in the presence of excess sulfur dioxide and pyridine in order to neutralize the acidic reaction products and drive the reaction to completion.

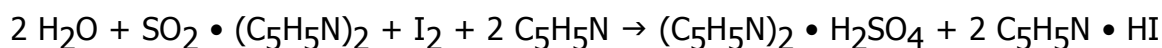

Two key developments have since lead to the currently accepted description of the Karl Fischer reaction. First, pyridine acts as a pH buffer and does not play a direct role in the reaction. This has allowed reagent formulators to replace pyridine with bases which are both less toxic and result in pH ranges that facilitate faster and more accurate titrations. Second, the species that reacts with water is not sulfur dioxide but the monomethyl sulfite ion resulting from the reaction between sulfur dioxide and methanol. Subsequently, researchers showed that higher alcohols can be used in place of methanol. The Karl Fischer reaction can therefore be described by the following generalized reaction sequence in which the H₂O, I₂, SO₂ and RN species react in a 1:1:1:3 stoichiometry.

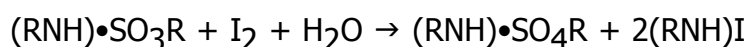

The maximum rate of the Karl Fischer reaction is reached between the pH range of 5.5 to 8 where all of the sulfur dioxide is available as methyl sulfite. If the pH drops below 5, the rate

TITRATION THEORY

of reaction decreases and titration endpoint become increasingly difficult to reach. If the pH exceeds 8, side reactions begin to occur between iodine and hydroxide or methylate ions, changing the titration stoichiometry.

While solvents not containing alcohols can be used for Karl Fischer analysis, they also have an effect on reaction stoichiometry. When alcohols are not present, the reaction resembles the Bunsen reaction stoichiometry where the consumption ratio of water to iodine is 2:1. In solvents containing higher alcohols, uneven ratios can be observed due to the relative abilities of higher alcohols to form the sulfite ester that reacts with water. Issues resulting from solvent-induced variation in stoichiometry are not typically encountered during routine analysis for two reasons. First, titrant standardization and sample analysis are carried out in the same titration medium and under the same conditions, effectively compensating for any variation in reaction behavior. Second, most Karl Fischer reagent systems are formulated to support standard KF reaction stoichiometry.

2.2.1.2 Volumetric Karl Fischer Titrations

In volumetric Karl Fischer titrations, the iodine for the Karl Fischer reaction is introduced via the titrant. This method is suitable for higher water contents: 100 ppm – 100%. The exact strength of the titrant (titer) is determined by standardization with a water standard. The other reaction components (sulfur dioxide, base, alcohol) can either be introduced by the titrant (one-component system) or by the solvent (two-component system). One-component reagent systems can utilize a custom solvent or solvent mixture since all of the Karl Fischer reaction components are in the titrant. However, one-component reagents do not have very stable titers, do not have a long shelf life, and suffer slower titration speeds. Two-component reagent systems have the advantage of fast titration speeds, stable titers, and long shelf lives, but choice of solvent is limited to commercial availability.

2.2.1.3 Coulometric Karl Fischer Titrations

In coulometric Karl Fischer titrations, the iodine for the Karl Fischer reaction is generated electrolytically inside the titration vessel, as opposed to introducing iodine via a titrant solution. This method is suitable for lower water contents: 1 ppm – 5%. The generator consists of two electrodes: an anode and a cathode. The reaction that occurs at each can be summarized as follows:

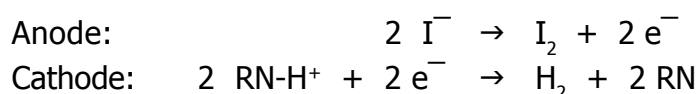

The iodine that is generated at the anode reacts with the water from the sample according to the Karl Fischer reaction. The amount of water that is reacted during a titration can be calculated based on the total charge that has passed through the generator. According to the Karl Fischer reaction (in protic solvents), 1 mole of water is titrated by 1 mole of iodine. According to the anodic reaction above, 1 mole of iodine is generated with 2 moles of electrons. Faraday's Constant states that 1 mole of electrons equates to 96485 coulombs (C) of electricity. Therefore, 96485 coulombs will cause 0.5 moles of water to be titrated, or 1 coulomb equals 93.36 μg of water:

$$1 \text{C} \cdot \left(\frac{1 \text{ mol e}^-}{96485 \text{ C}} \right) \cdot \left(\frac{1 \text{ mol I}_2}{2 \text{ mol e}^-} \right) \cdot \left(\frac{1 \text{ mol H}_2\text{O}}{1 \text{ mol I}_2} \right) \cdot \left(\frac{18.015 \text{ g H}_2\text{O}}{1 \text{ mol H}_2\text{O}} \right) = 9.336 \cdot 10^{-5} \text{ g H}_2\text{O} \\ = 93.36 \mu\text{g H}_2\text{O}$$

The amount of current that passes through the generator can easily and accurately be measured by the electronics of the titrator. Therefore, coulometric Karl Fischer titrations are considered absolute - standardization is not necessary. Water standards can be titrated as a system check to ensure proper system functioning.

2.2.1.3.1 Generator Electrodes with Diaphragm

The first coulometric Karl Fischer titrators used a diaphragm cell. In this design, the anode and cathode of the generator are separated by a diaphragm made typically of porous frit glass. The diaphragm serves to prevent the iodine generated at the anode from being reduced at the cathode, which would cause false high water determinations. The anode compartment contains the Karl Fischer reaction components (sulfur dioxide, methanol, base) and iodide salts for the generation of molecular iodine. The cathode compartment contains a source of hydrogen ions, typically ammonium salts.

Diaphragm titrations have some disadvantages. The first disadvantage is the higher drift rates that occur due to moisture collecting inside the catholyte. Since the Karl Fischer reaction only occurs in the anode compartment, moisture inside the catholyte cannot be eliminated by pre-titration. Instead of being pre-titrated, the moisture inside that catholyte will slowly diffuse across the diaphragm during drift analysis and sample analysis, and will add to the apparent drift rate. The second disadvantage is the risk of diaphragm blockage or contamination. Substances in the sample matrix may clog the diaphragm, or salts could precipitate inside the diaphragm. A clogged diaphragm will prevent ion migration which, in severe cases, will block the electrolytic reaction of the generator. The third disadvantage is difficulty in cleaning. The diaphragm does not absorb or drain fluid quickly, making cleaning very time-consuming. The cathode compartment itself is also not very accessible for cleaning.

2.2.1.3.2 Generator Electrodes without Diaphragm

To overcome the drawbacks of diaphragm titrations, diaphragm-less titration systems were made through modification of the generator's design and modification of the reagent. The cathode's surface is much smaller compared to the anode, allowing the generated iodine to react before possibly reaching the cathode. The reagent is also modified to prevent oxidizable sulfur compounds from forming.

Diaphragm-less titration offers very low drift rates and easy cell maintenance, but there are several drawbacks. First, side reactions are prone to occur particularly at slower titration rates. Therefore, samples with very low water contents may suffer from false high concentrations. Second, compounds that are easily reduced will react at the cathode and produce water, causing false high concentrations. These compounds include nitro compounds, unsaturated hydrocarbons, and certain metals.

TITRATION THEORY

2.2.1.4 Visual Indication of Karl Fischer Titrations

Visual methods, originally used by Karl Fischer, are limited in application, require a high degree of skill and have been made obsolete by electrometric indication. For successful visual indication, titration samples must be colorless. Additionally, the solution coloration varies between polar and non-polar titration media.

After the titration equivalence point all of the water in the titration solution has been reacted. The next drop of titrant added to the solution after the equivalence point contains iodine that will remain in the titration solution. Thereafter, the concentration of iodine in the titration solution increases and the solution develops a yellow, and eventually brown, color. It is difficult, even for an experienced analyst, to generate reproducible endpoint coloration between successive titrations.

2.2.1.5 Electrometric Indication of Karl Fischer Titrations

Biamperometric and bivoltametric indication are the two types of electrometric detection methods commonly used for indication of Karl Fischer titrations. Both methods use either a double platinum pin or a double platinum ring electrode to detect excess iodine in a titration solution. After the titration equivalence point, all of the water in the titration solution has been reacted. The next dose of titrant added to the solution contains iodine, which reacts at the electrode according to the reactions below.



The excess iodine is easily reduced at the cathode, and the resulting iodide is oxidized at the anode.

Both electrometric methods of indication rely on electrons (current) being carried through a titration solution by the oxidation-reduction reactions described above.

Biamperometric indication involves monitoring the flow of current through the titration solution while a constant voltage is applied across the platinum elements of the electrode. When water is present in the titration solution and there is no excess iodine, only a minimal current flows between the electrode elements. After the equivalence point, when iodine is present, the current flow increases to a few μA .

Bivoltametric indication involves measuring the voltage required to maintain a constant current flow between electrode elements. A small direct or alternating current called a polarization current (I_{pol}) is applied between the electrode pins or rings and the resulting voltage is measured in order to monitor the titration progress.

L-shaped titration curves are generated for both methods by plotting either the electrode current or voltage against the volume of titrant added during the titration.

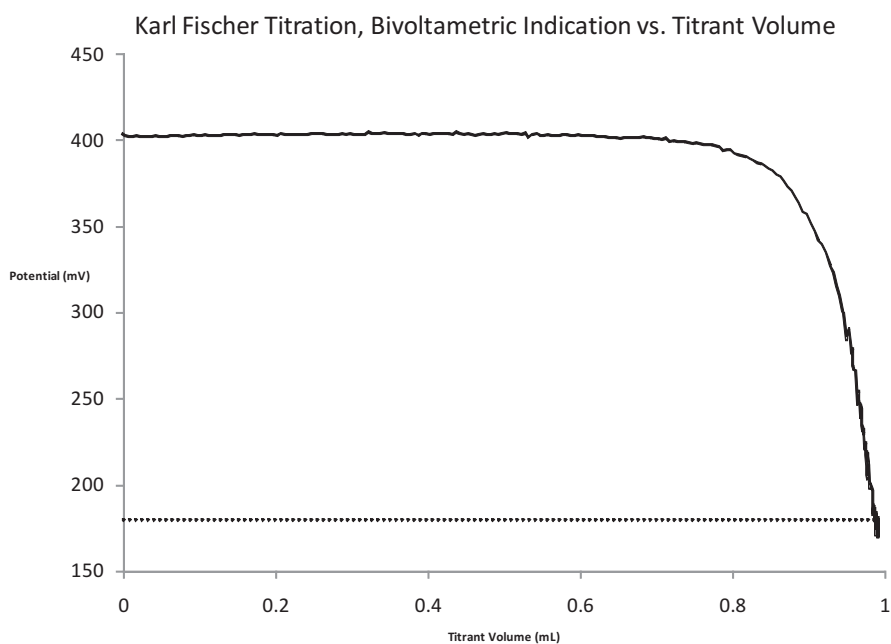

Electrometric methods result in over-titration or titration past the equivalence point where excess iodine is present in the titration solution. Titration past the equivalence point is acceptable for two reasons. First, due to the sensitivity of the electrometric methods, titrations are always carried out to the exact same, slight excess of iodine resulting in highly reproducible titrations. Second, the accuracy of electrometrically indicated titrations are not affected by the over-titration because the slight excess of iodine has been accounted for during the standardization of the titrant.

2.2.2 Acid-Base Titrations

Acid–base titrations are the most common type of titrations. Acid–base titrations are based upon a reaction between an acid and a base, a stoichiometric neutralization, or the exchange of protons. Virtually all acid–base titrations are carried out using a strong acid or a strong base as the titrant. The endpoint of a titration carried out with a weak acid or a weak base, would be difficult to detect due to a small change in pH at the equivalence point.

Chemical indicators are often used to determine the endpoint. The indicator will change color to signify that the end of the titration has been reached. When choosing the proper indicator you should select one that has a pK_a as close to the endpoint of the titration. The color-change region of the indicator is usually ± 1 pH unit around the pK_a . The theoretical titration curve is useful for illustrating how the solution will change during the real titration, and allowing the proper selection of an endpoint or an indicator.

TITRATION THEORY

Figure 3 shows a traditional titration curve. The curve is obtained by plotting the pH value against the volume of NaOH added.

Figure 3.

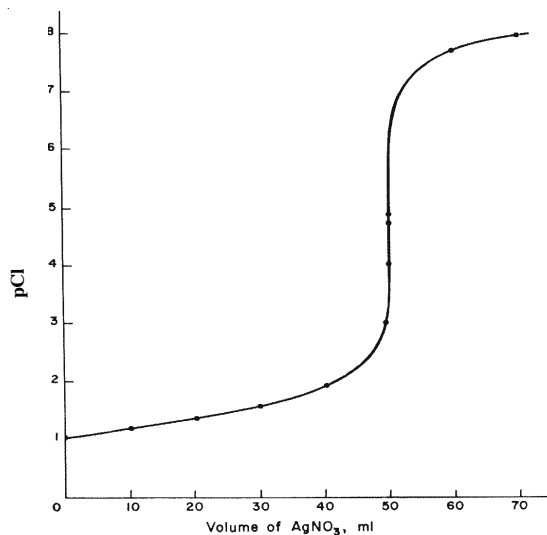

2.2.3 Argentometric Titrations

Argentometric titrations use silver (nitrate) as the titrant and are generally precipitation titrations, as many silver salts are insoluble. These titrations are commonly used to titrate and determine the concentration of bromide, chloride, cyanide, iodide, and sulfide.

Argentometric titrations can be done with Mohr's indicator, when all of the chloride has reacted, a red silver chromate precipitate is formed or the titration can be easily followed with a silver ISE (or chloride ISE for chloride titrations) and a reference electrode.

Figure 4.

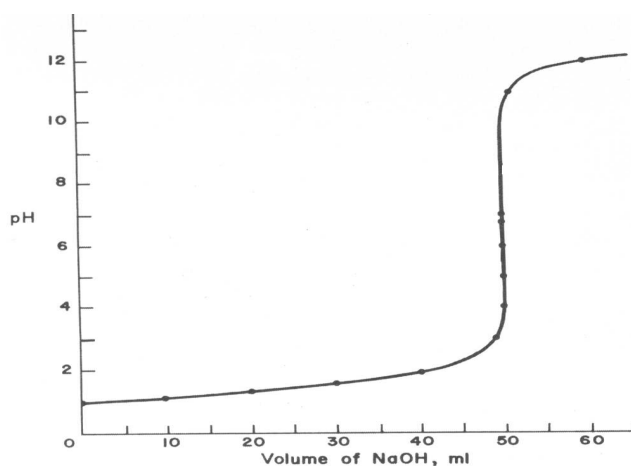

Figure 4 shows the titration of 50 mL of 0.1N NaCl with 0.1N AgNO₃. The potentiometric signal is from a chloride ISE, and is plotted as pCl (- log [Cl⁻]).

2.2.4 Complexometric Titrations

A complex is a species where a central metal ion is covalently bonded to one or more electron donating groups called ligands. In a complexometric titration, metal ions are titrated using a titrant that binds strongly to it. Often these titrants contain EDTA or CDTA, polydentate ligands that form very stable coordination compounds with metal ions. The complexation reaction must be fast in order to be useful for direct titration. Some metal ions react too slowly with EDTA for a direct titration.

An indicator electrode that responds to the metal ion can be used to monitor the titration progress. The titration curve will appear similar to a usual potentiometric titration. Complexation indicators change color at the endpoint as all metal ions are "consumed", or complexed by the titrant.

The titration curve will appear similar to a potentiometric titration, when using an indicator electrode that responds to the metal ion (see Figure 5).

Figure 5.

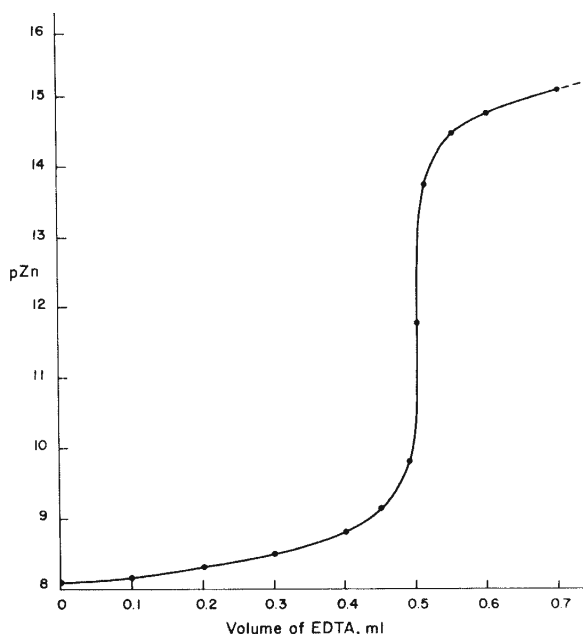

2.2.5 Ion Selective Titrations

The most popular ion selective titration is an acid-base titration. The hydrogen ion concentration is specifically measured and monitored during the titration process to locate the equivalence point. Using an ion selective electrode (ISE) as the indicator electrode, the potentiometric signal (in mV) is used to directly follow a specific ion's concentration (or activity).

Examples of ISE titrations include titrating fluoride with an aluminum titrant using a fluoride ISE, chloride with silver nitrate using a chloride ISE, sodium with a sodium ISE, etc. The equivalence point can be determined by plotting the mV value vs. the amount of titrant added.

2.2.6 Non-aqueous Solvent Acid-Base Titrations

Non-aqueous solvents must be used to titrate very weak acids and bases due to the inherent leveling effect water has on all acids and bases dissolved in it. A wide variety of weak acids and bases can be titrated using non-aqueous solvents. Mixtures of acids or bases can often be individually analyzed in a single sequential titration.

TITRATION THEORY

Titration of Acids

Weak acids with pK_a 's up to about 11 can be titrated in non-aqueous solvents. These include carboxylic acids, enols, phenols, imides, sulfonic acids, and inorganic acids. Water or lower alcohols are suitable for titrating medium to strong acids (pK_a less than 5). Titrating a weaker acid with a strong base titrant requires a solvent less acidic than water or ethanol/methanol. Solvents such as acetone, acetonitrile, t-butyl alcohol, dimethylformamide, isopropanol and pyridine have been found to work well for acid-base titrations of strong, medium and weak acids/bases. Titrants include alcoholic potassium hydroxide and various sodium or potassium alkoxides in a 10:1 mixture of benzene/methanol. The best titrants are quaternary ammonium hydroxides (such as tetrabutylammonium hydroxide) due to good solubility of tetraalkylammonium salts of the titrated acids and the clean potentiometric titration curve obtained (see Figure 6).

Titration of Bases

Weak bases with pK_b 's up to about 11, which do not ionize with water, can be titrated in non-aqueous solvents. These bases include aliphatic and aromatic amines, basic nitrogen heterocycles, alkali metal and amine salts of acids, and many other organic basic compounds. Titrating a weak base with a strong acid titrant requires a basic solvent that is as weak as possible. Water and alcohols allow the titration of medium strength bases such as aliphatic amines ($pK_b = 4$ to 5), but not the titration of weaker bases such as pyridine ($pK_b = 8.8$). Glacial acetic acid works well for weak bases and has been used extensively. Less basic solvents such as acetone, acetonitrile, and nitromethane extend the range of titrable compounds.

The endpoint for non-aqueous titrations are usually determined potentiometrically using a pH glass electrode, a modified calomel or double junction reference electrode with a low-flow rate reference junction. Good potentiometric titration curves are obtained in most solvents, except those with very low dielectric constants such as benzene, chloroform and others, when high electrical resistance of the solvent causes unstable potentials.

2.2.7 Precipitation Titrations

Precipitation titrations allow for faster analysis compared to the old gravimetric analysis, where a precipitate is formed, filtered, dried and weighed to analyze a compound. Typically silver halides, silver thiocyanate and a few mercury, lead, and zinc salts are titrated using this method. The chemical reactions must form an insoluble salt and precipitate out quickly in order to be analyzed by this method. When the reaction is not quick, a back titration can be used. A measured excess of the precipitating reagent (titrant) is added to force the reaction to occur, and then unreacted titrant is then titrated with a standard solution of another reagent.

2.2.8 Redox Titrations

There are a number of oxidation-reduction reactions that can be used to determine unknown concentration by titration. If the reaction goes to completion, is fast and has an analytical signal available to follow it, a titration can be performed. The term "fast" means that each addition of titrant is reacted completely and the sensing electrode is able to detect the change in solution in less than one second.

Redox titrations are potentiometric titrations where the mV signal from a combination ORP (redox) electrode (usually with a platinum indicator electrode) is used to follow the reaction of oxidant/reductant. The electrode potential is determined by the Nernst equation and is controlled by the oxidant reductant ratio.

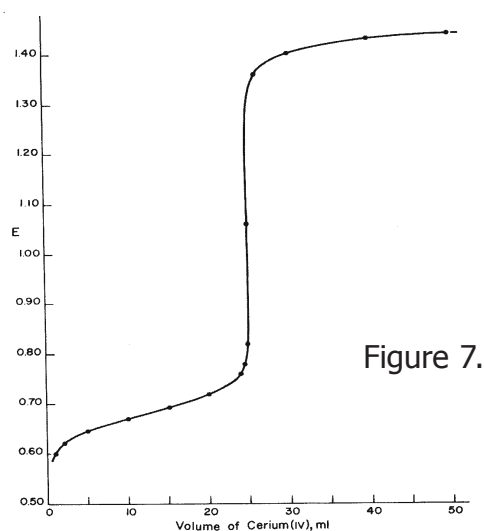
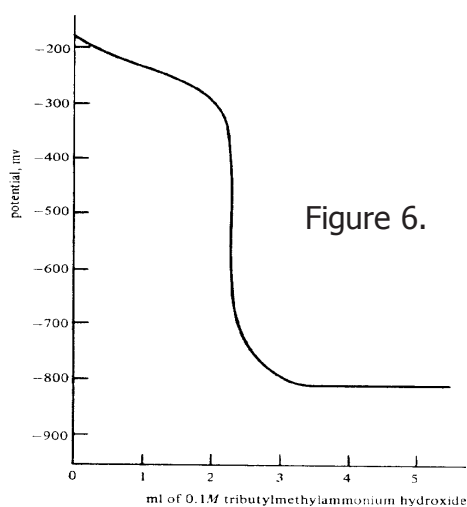

Visual indicators such as Ferrion are also available. The oxidized and reduced form of the indicator will have different colors and can be used to determine the end point.

Various reductants can be determined by titrants with oxidants such as potassium permanganate, potassium chromate or iodine. Commonly used reductants that are used as titrants include sodium thiosulfate, and ferrous ammonium sulfate.

As with Acid-Base titrations the potential changes dramatically at the equivalence point.

2.3 Titrations According to The Titration Sequence

2.3.1 Back Titrations

Back titrations are generally used when a reaction is too slow to be directly accomplished during a "direct" titration, where the reaction goes to completion within a few seconds. In a back titration, a large excess of a reagent is added to the sample solution, helping a slow reaction to go to completion. The un-reacted, excess reagent is then titrated. The difference in the total volume of the first reagent added and amount determined from the second titration is the quantity of reagent required to complete the first reaction.

2.3.2 Multiple End Point Titrations

Under certain conditions, some titrations can exhibit more than one equivalence point and be titratable to the individual end points to determine the concentration of each individual component. Examples of these types of titrations include acid-base, where different strength acid or bases are in a mixture; redox, where each species has a different reduction potential; complexometric, where different species are separately titratable; and acid-base, using polyprotic acids (the pK_a of the different protons varies enough to separate them).

Figure 8 shows three different types of multiple end point titrations. "A" shows the titration of a polyprotic acid. The different acid strengths of the first and second proton can be determined. "B" illustrates a mixture of two different metal redox species, where the different redox potentials allow the species to be separated. "C" is the titration of a solution containing strong, weak, and very weak acids.

TITRATION THEORY

Figure 8.

A

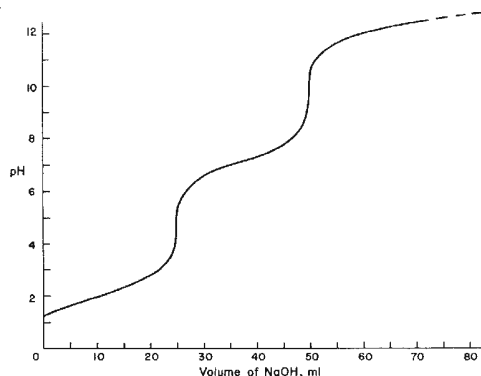

B

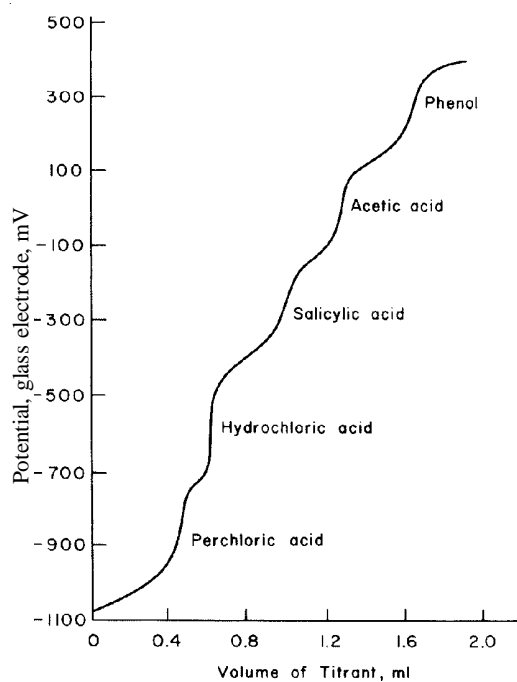
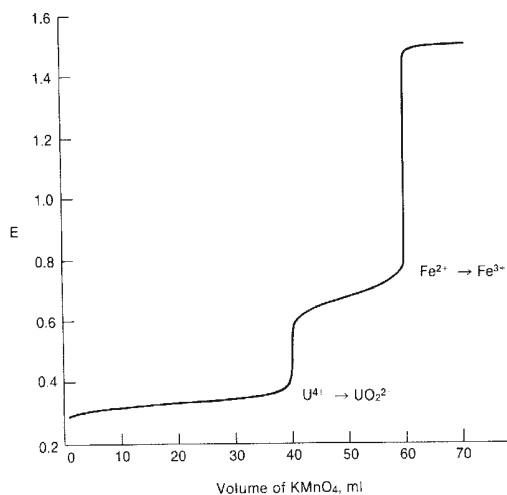

C

3 INTRODUCTION TO TITRATION APPARATUS AND TYPICAL TITRATION PROCEDURE

3.1 Manual Titration

Apparatus required for manual titration include:

- Volumetric Burette, for precisely controlled delivery of titrant to the reaction vessel;
- An Erlenmeyer, or similar flask, that facilitates constant mixing or swirling required to ensure solution homogeneity;
- Volumetric pipettes for the precise addition of samples and indicator solutions;
- Standard titrant solutions of known concentration;
- A visual or instrumental indicator for detecting the completion of the reaction.

A typical manual titration consists of the following steps:

1. A volumetric pipette is typically used to add a known volume of sample to the flask;
2. An indicator solution or instrument probe is added to the flask;
3. A burette is used to measure the addition of titrant to the flask and dispense titrant in a controlled manner;
4. Titrant is added via the burette until the method indication signals the reaction endpoint;
5. The concentration of analyte is calculated based on the concentration and volume of titrant required to reach the endpoint and the reaction stoichiometry.

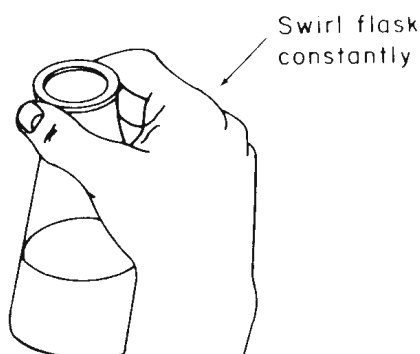
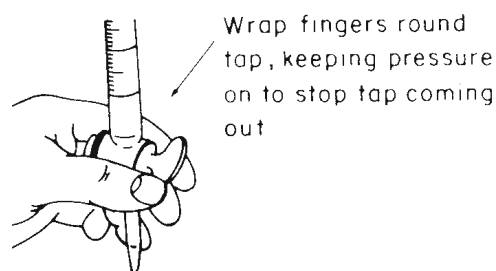

TITRATION THEORY

3.2 Automatic Titration

Automatic titrators are high-precision analytical instruments that deliver the titrant, monitor the physical change associated with the titration reaction, automatically stops at the endpoint and calculates the concentration of the analyte. Automatic titrators are best for repetitive titrations and high-accuracy analyses.

An automatic titrator must have an accurate liquid dispensing system. In high accuracy systems like the **HI 900**-series titrators, the liquid dispensing system consists of a stepper-motor driven piston syringe burette capable of accurately and precisely dispensing very small volumes of titrant, a valve system to switch between titrant intake and outlet and an anti-diffusion dispensing tip. These three main subsystem components must be as accurate as possible, with very low gear backlash in the burette pump, minimal piston seal flexing, precision ground inner diameter of the glass syringe, a low dead volume valve, minimal evaporation/permeation, and chemically resistant tubing.

Apparatus required for automatic titration include:

- An automatic titrator, equipped with a burette;
- A beaker;
- An electronic stirring system, either a propeller stirrer or a magnetic stir bar and stir plate;
- Volumetric pipettes for the precise addition of samples;
- Standard titrant solutions of known concentration;
- An electrode system that can be used to determine the endpoint of the titration.

A typical automatic titration consists of the following steps:

1. Set up the automatic titrator according to the manufacturer's instructions;
2. A volumetric pipette is typically used to add a known volume of sample to the beaker;
3. Submerge the propeller stirrer or add the stir bar to the beaker, and turn on;
4. Start the titration, the titrator will automatically stop at the endpoint and determine the concentration of the analyte.

4 TITRATION RESULTS

4.1 Accuracy

The factors most critical to achieving accurate results with the **HI 900** titration systems are the concentration of the sample, size of the sample and having an optimized set of method parameters.

4.2 Repeatability

Repeatability, or the agreement between replicate determinations, is expressed quantitatively as the relative standard deviation (RSD).

4.3 Sources of Error

One of the advantages of volumetric analysis is excellent accuracy and precision. The sources of error can be grouped into sampling, titrant and standards, chemical reactions, endpoint determination and calculations.

4.3.1 Sampling Errors

- Selection of a non-homogeneous or non-representative sample;
- Sample changed or was contaminated during collection, storage or transfers;
- Poor technique when transferring sample to beaker or flask;
- Errors in the balance, calibrate and check balance regularly.

4.3.2 Errors with Titrant and Standard

4.3.2.1 Preparation Errors

Incorrect preparation due to:

- Poor technique in weighing the salt or when transferring to volumetric glassware;
- Low-purity of salts or water used to make titrant and standard;
- Dirty or wet glassware;
- Improper storage of titrant or standard which allows water gain, evaporation or deterioration;
- Failure to standardize frequently to adjust for change in titrant;
- Failure to flush titrator tubing with a volume of titrant before standardizing;
- Volume errors from pipettes and volumetric flasks, grade A glassware is required;
- Balance errors when weighing out salts, calibrate and check balance regularly.

TITRATION THEORY

4.3.2.2 Dispensing Errors

Incorrect dispensing due to:

- Dead valve volume and leaking valve;
- Inaccuracy in motor drive and gear lash/ backlash;
- Poor burette/ piston seal;
- Non-uniform diameter of burette glass cylinder;
- Chemical incompatibility with tubing or bubble generation;
- Density/ temperature changes in titrant.
- Inadequate volume to cover electrode.

4.3.3 Chemical Reaction Errors

- Inappropriate solvent or sample resulting in side reactions;
- Poor mixing of the titrant and solvent or sample in the titration vessel;
- Reaction between titrant and sample is not rapid;
- Reaction does not go to completion;
- Reaction has side reactions.

4.3.4 End Point Determination Errors

Most manual titrations use a visual indicator to indicate when the endpoint is reached and the titration should be stopped. Automatic titrators can use potentiometric electrodes to determine the end of a titration and the equivalence point. There are two predominant methods used to determine the equivalence point, first derivative and second derivative.

The inflection point of a potentiometric curve (mV vs. Volume) is normally assumed to be the equivalence point. The first derivative is often used to determine the inflection point. The maximum value of the first derivative (D mV vs. D V) corresponds to the theoretical equivalence point. During a titration it is rare to have a data point exactly at the first derivative maximum, the maximum value is determined by interpolating the first derivative data points.

The second derivative (D^2 mV vs. DV^2) can also be used to determine the equivalence point, and can offer advantages over the first derivative method. Second derivatives have increased sensitivity to smaller inflection points and easier numerical evaluation of the actual equivalence point. The value where the second derivative is equal to zero is the equivalence point. The second derivative requires fewer points located near the equivalence point, where data is often not obtained or not as reliable.

Errors in determining the endpoint can result from:

- Incorrect signals from the sensor;
- Sensor drift;
- Sensor or instrument has slow response, keep sensors in good condition;
- Inappropriate setting on the titrator.

5 CALCULATIONS

5.1 Equations Used in Volumetric Karl Fischer Titrations

5.1.1 Calculation of water content as % mass from samples measured by mass

$$C_{sample} = \frac{V_{titrant} \times Titer}{m_{sample} \times (1000 \text{ mg/g})} \times 100$$

C sample	Concentration of Sample (% w/w)
V titrant	Volume of Titrant (mL)
Titer	Titrant Titer (mg/mL)
m sample	Mass of Sample (g)

5.1.2 Calculation of water content as % mass from samples measured by volume

$$C_{sample} = \frac{V_{titrant} \times Titer}{V_{sample} \times d_{sample} \times (1000 \text{ mg/g})} \times 100$$

C sample	Concentration of Sample (% w/w)
V titrant	Volume of Titrant (mL)
Titer	Titrant Titer (mg/mL)
V sample	Volume of Sample (mL)
d sample	Density of Sample (g/mL)

5.1.3 Calculation of water content as % volume from samples measured by volume

$$C_{sample} = \frac{V_{titrant} \times Titer}{V_{sample} \times d_{water} \times (1000 \text{ mg/g})} \times 100$$

C sample	Concentration of Sample (% v/v)
V titrant	Volume of Titrant (mL)
Titer	Titrant Titer (mg/mL)
V sample	Volume of Sample (mL)
d water	Density of Water at Analysis Temperature (g/mL)

5.1.4 Calculation of water content as % mass subtracting Background Drift Rate

$$C_{sample} = \frac{(V_{titrant} \times Titer) - [Drift \times t \times (1 \text{ mg} / 1000 \mu\text{g})]}{m_{sample} \times (1000 \text{ mg/g})} \times 100$$

C sample	Concentration of Sample (% w/w)
V titrant	Volume of Titrant (mL)
Titer	Titrant Titer (mg/mL)
Drift	Background Drift Rate ($\mu\text{g}/\text{min}$)
t	Titration Duration (min)
m sample	Mass of Sample (g)

TITRATION THEORY

5.1.5 Calculation of water content in External Dissolution Samples

$$C_{sample} = \left[\frac{m_{solvent} \times (C_{solution} - C_{solvent})}{m_{sample}} + C_{solution} \right] \times 100$$

C sample	Concentration of Sample (% w/w)
m solvent	Mass of Solvent (g)
m sample	Mass of Sample (g)
C solution	Water Content of Dissolved Sample (w/w)
C solvent	Water Content of Solvent (w/w)

5.1.6 Calculation of water content in External Extraction Samples

$$C_{sample} = \frac{m_{solvent} \times (C_{supernatant} - C_{solvent})}{m_{sample} \times (1 - C_{supernatant})} \times 100$$

C sample	Concentration of Sample (% w/w)
m solvent	Mass of Solvent (g)
m sample	Mass of Sample (g)
C supernatant	Water Content of Supernatant (w/w)
C solvent	Water Content of Solvent (w/w)

5.1.7 Calculation of water content in Gaseous Samples

The water content of gases is normally reported in units of $\mu\text{g/L}$ or mg/L .

$$C_{sample} = \frac{V_{titrant} \times \text{Titer}}{\text{Flow Rate} \times \text{Flow Duration}}$$

C sample	Concentration of Sample (mg/L)
V titrant	Volume of Titrant (mL)
Titer	Titrant Titer (mg/mL)
Flow Rate	Sample Flow Rate (L/min)
Flow Duration	Sample Extraction Time (min)

To calculate the water content in %w/w the mass of the gas introduced into the titration vessel must be known. This can be determined by calculations using ideal gas laws or by measuring the mass of the sample container before and after a titration.

5.1.8 Calculation of Titer (water equivalent of the titrant) using sodium tartrate dihydrate containing 15.66% water by mass

$$C_{titrant} = \frac{m_{sample} \times C_{tartrate}}{V_{titrant}}$$

C titrant	Titrant Titer (mg/mL)
m sample	Mass of Sample (g)
C tartrate	Water Content of Tartrate (156.6 mg/g)
V titrant	Volume of Titrant (mL)

5.1.9 Calculation of Titer (water equivalent of the titrant) using water standards

$$C_{titrant} = \frac{m_{sample} \times C_{std} \times d_{pnd}}{V_{titrant}}$$

C titrant	Titrant Titer (mg/mL)
m sample	Mass of Sample (g)
C standard	Water Content of Standard (mg/g)
V titrant	Volume of Titrant (mL)

5.2 Equations Used in Titrations

The main variables used in calculating a result from a titration are the sample volume, the concentration of the titrant, and the volume of titrant required to reach the equivalence point. At the equivalence point, an equal number of equivalents of the analyte and titrant has been added.

5.2.1 Sample Calculation

By Mass

$$C_{sample} = \frac{V_{titrant} \times C_{titrant} \times Ratio \times FW_{analyte}}{m_{sample}} \times 100$$

C sample	Sample Concentration (g/100g)
V titrant	Volume of titrant
C titrant	Titrant Concentration (eq/L)
Ratio	Equivalence ratio of analyte/ titrant (mol analyte/ eq titrant)
FW analyte	Formula Weight of the Analyte (g/mol)
m sample	Mass of sample (g)

By Volume

$$C_{sample} = \frac{V_{titrant} \times C_{titrant} \times Ratio \times FW_{analyte}}{V_{sample}} \times 100$$

C sample	Sample Concentration (g/100mL)
V titrant	Volume of titrant
C titrant	Titrant Concentration (eq/L)
Ratio	Equivalence ratio of analyte/ titrant (mol analyte/ eq titrant)
FW analyte	Formula Weight of the Analyte (g/mol)
V sample	Volume of Sample (mL)

5.2.2 Standardize Titrant

Titrant standardization is the second most important calculation in titrations. A primary standard is titrated in order to determine the concentration of the titrant. This is essentially a typical titration calculated in "reverse", where the concentration of the solution is known and the titrant is unknown.

TITRATION THEORY

By Mass

$$C_{\text{titrant}} = \frac{m_{\text{standard}} \times \text{Ratio}}{FW_{\text{standard}} \times V_{\text{titrant}}}$$

C titrant	Titration Concentration (N)
m standard	Mass of Standard (g)
Ratio	Equivalence ratio of titrant/standard (eq titrant/ mol standard)
FW standard	Formula Weight of the Standard (g/mol)
V titrant	Volume of Titration (L)

By Volume

$$C_{\text{titrant}} = \frac{V_{\text{standard}} \times (1 \text{ L} / 1000 \text{ mL}) \times C_{\text{standard}}}{V_{\text{titrant}}}$$

C titrant	Concentration of titration (N)
V standard	Volume of Standard (mL)
C standard	Concentration of standard (eq/L)
V titrant	Volume of Titration (L)

5.2.3 Blank Titration

In a blank titration a pre-titration is performed, often times on the solvent to be used for the sample titration, and the titration volume required to reach the endpoint is noted. This blank value nullifies error due to titration required to react with the components of the titration solution matrix. The basic titration equation can be used for a blank titration, with the single modification that the volume of titration used in the blank titration should be subtracted from the regular titration titration volume.

$$C_{\text{sample}} = \frac{C_{\text{titrant}} \times (V_{\text{sample}} - V_{\text{blank}}) \times \text{Ratio} \times FW_{\text{analyte}}}{m_{\text{sample}}} \times 100$$

C Sample	Sample Concentration (g/100g)
C titrant	Titration Concentration (eq/L)
V sample	Volume of Titration required for the sample (L)
V blank	Volume of Titration required for the blank (L)
Ratio	Equivalence ratio of analyte/ titration (mol analyte/ eq titration)
FW analyte	Formula Weight of the Analyte (g/mol)
m sample	Mass of sample (g)

5.2.4 Multiple End Point Titration

Some titrations have two or more endpoints, each corresponding to the equivalence point for a specific reaction. Multiple endpoint titrations are similar to a blank titration in that the volume of titration required to reach the first endpoint is subtracted from the titration volume used to reach the next sequential endpoint.

$$C_{\text{sample 1}} = \frac{V_{\text{titrant 1}} \times C_{\text{titrant}} \times \text{Ratio} \times FW_{\text{analyte 1}}}{m_{\text{sample}}} \times 100$$

$$C_{sample2} = \frac{(V_{titrant2} - V_{titrant1}) \times C_{titrant} \times Ratio \times FW_{analyte2}}{m_{sample}} \times 100$$

$$C_{sample3} = \frac{(V_{titrant3} - V_{titrant2}) \times C_{titrant} \times Ratio \times FW_{analyte3}}{m_{sample}} \times 100$$

C sample1	Sample 1 Concentration (g/100g)
C sample2	Sample 2 Concentration (g/100g)
C sample3	Sample 3 Concentration (g/100g)
V titrant 1	Volume of titrant required to reach the first end point (L)
V titrant 2	Volume of titrant required to reach the second end point (L)
V titrant 3	Volume of titrant required to reach the third end point (L)
C titrant	Concentration of titrant (N)
Ratio	Equivalence ratio of analyte/ titrant (mol analyte/ eq titrant)
FW analyte 1	Formula Weight of the Analyte 1 (g/mol)
FW analyte 2	Formula Weight of the Analyte 2 (g/mol)
FW analyte 3	Formula Weight of the Analyte 3 (g/mol)
m sample	Weight of Sample (mL)

5.2.5 Back Titration

The equation used in back titration calculations is also similar to the equation for a blank titration. Instead of subtracting the initial amount of titrant needed to react with the blank, the amount of second titrant needed to react with the excess titrant added in the first titration is subtracted from the amount of the first titrant added. The difference between the two amounts is the amount of titrant necessary to reach the first equivalence point.

$$C_{sample} = \frac{(C_{titrant1} \times V_{titrant1} - C_{titrant2} \times V_{titrant2}) \times Ratio \times FW_{analyte}}{V_{sample}} \times 100$$

C sample	Sample Concentration (g/100mL)
C titrant 1	Concentration of titrant 1 (N)
V titrant 1	Volume of titrant 1 (L)
C titrant 2	Concentration of titrant 2 (N)
V titrant 2	Volume of titrant 2 (L)
Ratio	Equivalence ratio of analyte/ titrant (mol analyte/ eq titrant)
FW analyte	Formula Weight of the analyte (g/mol)
V sample	Volume of sample (mL)

TITRATION THEORY

6 GLOSSARY

Acid

A chemical species that can donate one or more protons (hydrogen ions).

Acid-Base Titration

Stoichiometric neutralization titrations, based upon the reaction that occurs between an acid and base.

Activity

A physical property corresponding to the concentration of all ions in a solution. Electrodes respond to activity.

Amperometric Titration

Titrations where the current flow between two electrodes (often a metal electrode and a reference electrode) are used to monitor the titration progress.

Analyte

The chemical species being measured in a titration.

Argentometric Titration

Titrations that use silver (nitrate) as the titrant. These titrations are typically precipitation titrations.

Automatic Titrator

An instrument designed to automatically carry out a titration. It will add the appropriate amount of titrant, determine the end-point and calculate the results.

Back Titration

A type of titration where an excess amount of titrant is added to a sample forcing a sluggish reaction to go to completion. The excess reagent is then "back" titrated with a second titrant.

Base

A chemical species that can accept one or more protons (hydrogen ions).

Biamperometric Indication

Uses a double platinum pin electrode to measure the current flow through a titration solution.

Bivoltametric Indication

Uses a double platinum pin electrode to measure the voltage required to maintain a constant current flow through a titration solution while constant voltage is applied across the platinum elements of the electrode.

Burette

A graduated cylindrical piece of laboratory glassware that is used to dispense precise amounts of solution.

Complex Ion

A species where a central metal ion is covalently bonded to one or more electron donating groups called ligands.

Complexometric Titrations

Metal ions are titrated using a titrant that binds strongly to it. The titrants often contain Ethylenediaminetetraacetic Acid (EDTA) or Cyclohexylenedinitrilotetraacetic Acid (CDTA).

End point

The point where a titration is stopped because a physical change in the solution has indicated a completed titration. Titration end points typically coincide with the equivalence point. A fixed value end point (pH or mV), can be used as well. The titration will stop at the desired point regardless if the titration is complete.

Equivalence point

The point where the quantity of titrant is stoichiometrically equal to the quantity of analyte.

Formal

The theoretical number of equivalents per liter of the solution. It is used in solutions where the exact concentration of a species may be affected by the other ions present, therefore the stated concentration by not be exactly correct.

Gravimetric Analysis

A quantitative determination of an analyte based on the mass of the solid.

Indicator Electrode

An electrode that responds to the species of interest. The electrode potential is proportional to the concentration or activity of that ion in the solution being measured.

Indicators

Chemical indicators are typically organic dyes that change form under different physically conditions, causing a color change that can be seen by an analyst. Typically used in manual titrations. Chemical indicators have been replaced with electrometric indicators, which are used with automatic titrators.

Inflection Point

The point on a titration curve where the second derivative curve changes signs.

Ion Selective Electrode (ISE)

An electrode that responds to a specific ion, the electrode potential is proportional to the concentration or activity of that ion in the solution being measured.

Karl Fischer Titration

A titration that uses a chemical reaction that is specific for determining water.

Manual Titration

A titration that is carried out by hand, the analyst must add the appropriate amount of titrant, determine the end point and calculate the results.

Molar

The concentration of a solute in a solution.

Mole (mol)

A quantity of a chemical species. The molecular weight of a substance in grams is equal to the mass of one mole of the substance. One mole is equal to 6.022×10^{23} atoms or molecules.

Monochromator

A device that allows only a narrow range of wavelengths to pass through it by separating the light into different wavelengths.

Multiple End Point Titration

A titration that reacts multiple species in solution sequentially using the same titrant. The concentration of each analyte can be determined from their respective end points.

Nernst Equation

The fundamental equation relating cell voltage to the concentration of a solution.

TITRATION THEORY

Neutralization

A chemical reaction where an acid and a base react to form a neutral salt and water.

Non-aqueous

A solution that does not contain water.

Non-aqueous Titration

A titration that is performed in non-aqueous solutions. Typically used to titrate very weak acid and bases to eliminate the leveling effect water has on all acids and bases dissolved in it.

Normal

The concentration of a solution which accounts for any stoichiometric difference between the various species in a solution.

Oxidation/ Reduction Potential (ORP)

A voltage generated in a solution which is a result of the ratio of the oxidized to reduce species. Typically measured potentiometrically with an ORP sensor.

Oxidant

The species that is accepting electrons in a redox reaction.

Pipette

Scientific apparatus that is used to deliver precise volumes of liquids.

Polyprotic Acid

Acids that are capable of donating more than one proton per acid molecule.

Potentiometric Titration

A titration in which the endpoint is determined by monitoring the voltage of the solution using an electrode.

Precipitation Titration

A titration in which the analyte reacts with the titrant to form an insoluble compound. The end point is typically detected with an ISE sensitive to either the analyte or titrant.

Reagent

The chemical added in a titration that causes the given reaction to occur.

Reduction-Oxidation Reaction (redox)

A chemical reaction in which the atoms involved in the reaction have their oxidation numbers changed. Reduction is the gain of electrons, which decreases the oxidation number. Oxidation is the loss of electrons, which increases the oxidation number.

Reductants

The electron donor in a redox reaction.

Reference Electrode

An electrode that supplies a constant electrode potential. It is used in combination with an "indicator" electrode, allowing for the "indicator" electrode potential to be measured.

Relative Standard Deviation (RSD)

A measure of the amount of relative variation in a set of data. It is calculated by dividing the standard deviation by the mean: $RSD = (\text{Standard Deviation of } X) * 100 / (\text{Mean of } X)$.

Repeatability

The variation in sample measurements taken by a single person or instrument under the same conditions.

Spectrophotometric Titration

A titration in which the end point is marked by a change in the color and/or color intensity.

Stoichiometry

The quantitative relationship of the reactants and products in a chemical reaction.

Titrant

The chemical added in a titration that causes the given reaction to occur.

Titration

A quantitative, volumetric procedure used in analytical chemistry to determine the concentration of an analyte in solution. The concentration of the analyte is determined by slowly adding a titrant to the solution. As the titrant is added, a chemical reaction between the titrant and the analyte occurs.

Titration Curve

A graph containing the physical data obtained for a titration. The data plotted is often an independent variable (volume of titrant) vs. a dependent variable (pH of the solution). From the titration curve, the equivalence point or end point can be determined.

Titr THEORY 904

07/13